

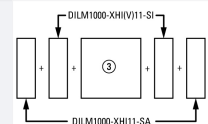

**Contactor, 380 V 400 V 110 kW, 2 N/O, 2 NC, RAC 240: 190 - 240 V 50/60 Hz, AC operation, Screw connection**

**Part no. DILM225A/22(RAC240)**  
**Catalog No. 139547**  
**Alternate Catalog XTCE225H22B**  
**No.**  
**EL-Nummer 4134287**  
**(Norway)**

**Delivery program**

Product range				Contactors
Application				Contactors for Motors
Subrange				Standard devices greater than 170 A
Utilization category				AC-1: Non-inductive or slightly inductive loads, resistance furnaces NAC-3: Normal AC induction motors: starting, switch off during running AC-4: Normal AC induction motors: starting, plugging, reversing, inching
Connection technique				Screw connection
<b>Rated operational current</b>				
AC-3				
380 V 400 V	$I_e$	A	225	
AC-1				
Conventional free air thermal current, 3 pole, 50 - 60 Hz				
Open				
at 40 °C	$I_{th} = I_e$	A	386	
enclosed	$I_{th}$	A	275	
Conventional free air thermal current, 1 pole				
open	$I_{th}$	A	707	
enclosed	$I_{th}$	A	636	
<b>Max. rating for three-phase motors, 50 - 60 Hz</b>				
AC-3				
220 V 230 V	P	kW	70	
380 V 400 V	P	kW	110	
660 V 690 V	P	kW	150	
1000 V	P	kW	108	
AC-4				
220 V 230 V	P	kW	51	
380 V 400 V	P	kW	90	
660 V 690 V	P	kW	110	
1000 V	P	kW	77	
Contact sequence				
Can be combined with auxiliary contact				DILM1000-XHI...
Actuating voltage				RAC 240: 190 - 240 V 50/60 Hz
Voltage AC/DC				AC operation
<b>Contacts</b>				
N/O = Normally open				2 N/O
N/C = Normally closed				2 NC
<b>Auxiliary contacts</b>				
possible variants at auxiliary contact module fitting options				on the side: 2 x DILM1000-XHI(V)11-SI; 2 x DILM1000-XHI11-SA
Side mounting auxiliary contacts				
<b>Instructions</b>				Interlocked opposing contacts according to IEC/EN 60947-5-1 Appendix L, inside the auxiliary contact module

		Auxiliary contacts used as mirror contacts according to IEC/EN 60947-4-1 Appendix F (not N/C late open)
<b>Instructions</b>		integrated suppressor circuit in actuating electronics 660 V, 690 V or 1000 V: not directly reversing

## Technical data

### General

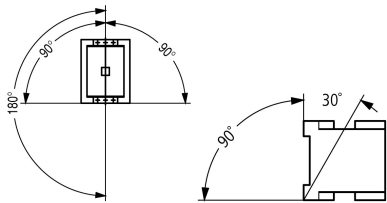
Standards			IEC/EN 60947, VDE 0660, UL, CSA
Lifespan, mechanical			
AC operated	Operations	$\times 10^6$	10
Operating frequency, mechanical			
AC operated	Operations/h		3000
Climatic proofing			Damp heat, constant, to IEC 60068-2-78 Damp heat, cyclic, to IEC 60068-2-30
Ambient temperature			
Open		°C	-40 - +60
Enclosed		°C	- 40 - + 40
Storage		°C	- 40 - + 80
Mounting position			
Mechanical shock resistance (IEC/EN 60068-2-27)			
Half-sinusoidal shock, 10 ms			
Main contacts			
N/O contact		g	10
Auxiliary contacts			
N/O contact		g	10
N/C contact		g	8
Degree of Protection			IP00
Protection against direct contact when actuated from front (EN 50274)			Finger and back-of-hand proof with terminal shroud or terminal block
Altitude		m	Max. 2000
Weight			
AC operated		kg	3.54
DC operated		kg	3.54
Weight		kg	3.54
Terminal capacity main cable			
Flexible with cable lug		mm <sup>2</sup>	50 - 185
Stranded with cable lug		mm <sup>2</sup>	70 - 185
Solid or stranded		AWG	2/0 - 250 MCM
Flat conductor	Lamellenzahl x Breite x Dicke	mm	Fixing with flat cable terminal or cable terminal blocks See terminal capacity for cable terminal blocks
Busbar	Width	mm	32
Main cable connection screw/bolt			M10
Tightening torque		Nm	24
Terminal capacity control circuit cables			
Solid		mm <sup>2</sup>	1 x (0.75 - 2.5) 2 x (0.75 - 2.5)
Flexible with ferrule		mm <sup>2</sup>	1 x (0.75 - 2.5) 2 x (0.75 - 2.5)
Solid or stranded		AWG	18 - 14
Control circuit cable connection screw/bolt			M3.5
Tightening torque		Nm	1.2
Tool			
Main cable			

Width across flats	mm	16
Control circuit cables		
Pozidriv screwdriver	Size	2

### Main conducting paths

Rated impulse withstand voltage	$U_{imp}$	V AC	8000
Overvoltage category/pollution degree			III/3
Rated insulation voltage	$U_i$	V AC	1000
Rated operational voltage	$U_e$	V AC	1000
Safe isolation to EN 61140			
between coil and contacts		V AC	500
between the contacts		V AC	500
Making capacity (p.f. to IEC/EN 60947)		A	2700
Breaking capacity			
220 V 230 V		A	2250
380 V 400 V		A	2250
500 V		A	2250
660 V 690 V		A	2250
1000 V		A	760
Component lifespan			AC1: See → Engineering, characteristic curves AC3: See → Engineering, characteristic curves AC4: See → Engineering, characteristic curves
Short-circuit rating			
Short-circuit protection maximum fuse			
Type "2" coordination			
400 V	gG/gL 500 V	A	315
690 V	gG/gL 690 V	A	250
1000 V	gG/gL 1000 V	A	160
Type "1" coordination			
400 V	gG/gL 500 V	A	400
690 V	gG/gL 690 V	A	315
1000 V	gG/gL 1000 V	A	200

### AC

AC-1			
Rated operational current			
Conventional free air thermal current, 3 pole, 50 - 60 Hz			
Open			
at 40 °C	$I_{th} = I_e$	A	386
at 50 °C	$I_{th} = I_e$	A	345
at 55 °C	$I_{th} = I_e$	A	329
at 60 °C	$I_{th} = I_e$	A	315
enclosed	$I_{th}$	A	275
Notes			At maximum permissible ambient air temperature.
Conventional free air thermal current, 1 pole			
Note			at maximum permissible ambient air temperature
open	$I_{th}$	A	707
enclosed	$I_{th}$	A	636
AC-3			
Rated operational current			
Open, 3-pole: 50 – 60 Hz			
Notes			At maximum permissible ambient temperature (open.)
220 V 230 V	$I_e$	A	225
240 V	$I_e$	A	225
380 V 400 V	$I_e$	A	225
415 V	$I_e$	A	225

440V	I <sub>e</sub>	A	225
500 V	I <sub>e</sub>	A	225
660 V 690 V	I <sub>e</sub>	A	160
1000 V	I <sub>e</sub>	A	76
Motor rating	P	kWh	
220 V 230 V	P	kW	70
240V	P	kW	75
380 V 400 V	P	kW	110
415 V	P	kW	132
440 V	P	kW	138
500 V	P	kW	160
660 V 690 V	P	kW	150
1000 V	P	kW	108

<b>AC-4</b>			
Rated operational current			
Open, 3-pole: 50 – 60 Hz			
220 V 230 V	I <sub>e</sub>	A	164
240 V	I <sub>e</sub>	A	164
380 V 400 V	I <sub>e</sub>	A	164
415 V	I <sub>e</sub>	A	164
440 V	I <sub>e</sub>	A	164
500 V	I <sub>e</sub>	A	164
660 V 690 V	I <sub>e</sub>	A	120
1000 V	I <sub>e</sub>	A	55
Motor rating	P	kWh	
220 V 230 V	P	kW	51
240 V	P	kW	54
380 V 400 V	P	kW	90
415 V	P	kW	96
440 V	P	kW	102
500 V	P	kW	116
660 V 690 V	P	kW	110
1000 V	P	kW	77

### Condensator operation

Individual compensation, rated operational current I <sub>e</sub> of three-phase capacitors			
Open			
up to 525 V		A	220
690 V		A	133
Max. inrush current peak		x I <sub>e</sub>	30
Component lifespan	Operations	x 10 <sup>6</sup>	0.1
Max. operating frequency		Ops/h	200

### DC

Rated operational current, open			
DC-1			
Notes			see DILDC300/DILDC600 or on request

### Current heat loss

3 pole, at I <sub>th</sub> (60°)		W	45
Current heat loss at I <sub>e</sub> to AC-3/400 V		W	23

### Magnet systems

Voltage tolerance			
U <sub>S</sub>			190 - 240 V 50/60 Hz
AC operated	Pick-up		0.8 x U <sub>S min</sub> - 1.15 x U <sub>S max</sub>
AC operated	Drop-out		0.25 x U <sub>S min</sub> - 0.6 x U <sub>S max</sub>
Power consumption of the coil in a cold state and 1.0 x U <sub>S</sub>			

Pull-in power	Pick-up	VA	210
Pull-in power	Pick-up	W	180
Sealing power	Sealing	VA	2.6
Sealing power	Sealing	W	2.1
Duty factor		% DF	100
Changeover time at 100 % U <sub>S</sub> (recommended value)			
Main contacts			
		ms	60
		ms	40

### Electromagnetic compatibility (EMC)

Electromagnetic compatibility			This product is designed for operation in industrial environments (environment A). Its use in residential environments (environment B) may cause radio-frequency interference, requiring additional noise suppression measures.
-------------------------------	--	--	---

### Rating data for approved types

Switching capacity			
Maximum motor rating			
Three-phase			
200 V 208 V		HP	60
230 V 240 V		HP	75
460 V 480 V		HP	150
575 V 600 V		HP	200
General use		A	250
Auxiliary contacts			
Pilot Duty			
AC operated			A600
DC operated			P300
General Use			
AC		V	600
AC		A	15
DC		V	250
DC		A	1
Short Circuit Current Rating		SCCR	
Basic Rating			
SCCR		kA	10
max. Fuse		A	700
max. CB		A	600
480 V High Fault			
SCCR (fuse)		kA	100
max. Fuse		A	600 Class J
SCCR (CB)		kA	65
max. CB		A	350
600 V High Fault			
SCCR (fuse)		kA	100
max. Fuse		A	600 Class J
SCCR (CB)		kA	50
max. CB		A	350
Special Purpose Ratings			
Definite Purpose Ratings (100,000 cycles acc. to UL 1995)			
LRA 480V 60Hz 3phase		A	2016
FLA 480V 60Hz 3phase		A	336
LRA 600V 60Hz 3phase		A	1680
FLA 600V 60Hz 3phase		A	280

## Design verification as per IEC/EN 61439

Technical data for design verification			
Rated operational current for specified heat dissipation	$I_n$	A	225
Heat dissipation per pole, current-dependent	$P_{vid}$	W	7.67
Equipment heat dissipation, current-dependent	$P_{vid}$	W	0
Static heat dissipation, non-current-dependent	$P_{vs}$	W	2.1
Heat dissipation capacity	$P_{diss}$	W	0
Operating ambient temperature min.		°C	-40
Operating ambient temperature max.		°C	60
IEC/EN 61439 design verification			
10.2 Strength of materials and parts			
10.2.2 Corrosion resistance			
			Meets the product standard's requirements.
10.2.3.1 Verification of thermal stability of enclosures			
			Meets the product standard's requirements.
10.2.3.2 Verification of resistance of insulating materials to normal heat			
			Meets the product standard's requirements.
10.2.3.3 Verification of resistance of insulating materials to abnormal heat and fire due to internal electric effects			
			Meets the product standard's requirements.
10.2.4 Resistance to ultra-violet (UV) radiation			
			Meets the product standard's requirements.
10.2.5 Lifting			
			Does not apply, since the entire switchgear needs to be evaluated.
10.2.6 Mechanical impact			
			Does not apply, since the entire switchgear needs to be evaluated.
10.2.7 Inscriptions			
			Meets the product standard's requirements.
10.3 Degree of protection of ASSEMBLIES			
			Does not apply, since the entire switchgear needs to be evaluated.
10.4 Clearances and creepage distances			
			Meets the product standard's requirements.
10.5 Protection against electric shock			
			Does not apply, since the entire switchgear needs to be evaluated.
10.6 Incorporation of switching devices and components			
			Does not apply, since the entire switchgear needs to be evaluated.
10.7 Internal electrical circuits and connections			
			Is the panel builder's responsibility.
10.8 Connections for external conductors			
			Is the panel builder's responsibility.
10.9 Insulation properties			
10.9.2 Power-frequency electric strength			
			Is the panel builder's responsibility.
10.9.3 Impulse withstand voltage			
			Is the panel builder's responsibility.
10.9.4 Testing of enclosures made of insulating material			
			Is the panel builder's responsibility.
10.10 Temperature rise			
			The panel builder is responsible for the temperature rise calculation. Eaton will provide heat dissipation data for the devices.
10.11 Short-circuit rating			
			Is the panel builder's responsibility. The specifications for the switchgear must be observed.
10.12 Electromagnetic compatibility			
			Is the panel builder's responsibility. The specifications for the switchgear must be observed.
10.13 Mechanical function			
			The device meets the requirements, provided the information in the instruction leaflet (IL) is observed.

## Technical data ETIM 7.0

Low-voltage industrial components (EG000017) / Power contactor, AC switching (EC000066)			
Electric engineering, automation, process control engineering / Low-voltage switch technology / Contactor (LV) / Power contactor, AC switching (ecl@ss10.0.1-27-37-10-03 [AAB718015])			
Rated control supply voltage $U_s$ at AC 50HZ		V	190 - 240
Rated control supply voltage $U_s$ at AC 60HZ		V	190 - 240
Rated control supply voltage $U_s$ at DC		V	0 - 0
Voltage type for actuating			AC
Rated operation current $I_e$ at AC-1, 400 V		A	356
Rated operation current $I_e$ at AC-3, 400 V		A	225
Rated operation power at AC-3, 400 V		kW	110
Rated operation current $I_e$ at AC-4, 400 V		A	164
Rated operation power at AC-4, 400 V		kW	90
Rated operation power NEMA		kW	111
Modular version			No
Number of auxiliary contacts as normally open contact			2
Number of auxiliary contacts as normally closed contact			2
Type of electrical connection of main circuit			Rail connection
Number of normally closed contacts as main contact			0

Number of main contacts as normally open contact

3

## Approvals

Product Standards	IEC/EN 60947-4-1; UL 60947-4-1; CSA - C22.2 No. 60947-4-1-14; CE marking
UL File No.	E29096
UL Category Control No.	NLDX
CSA File No.	2389068
CSA Class No.	3211-04
North America Certification	UL listed, CSA certified
Specially designed for North America	No

## Characteristics

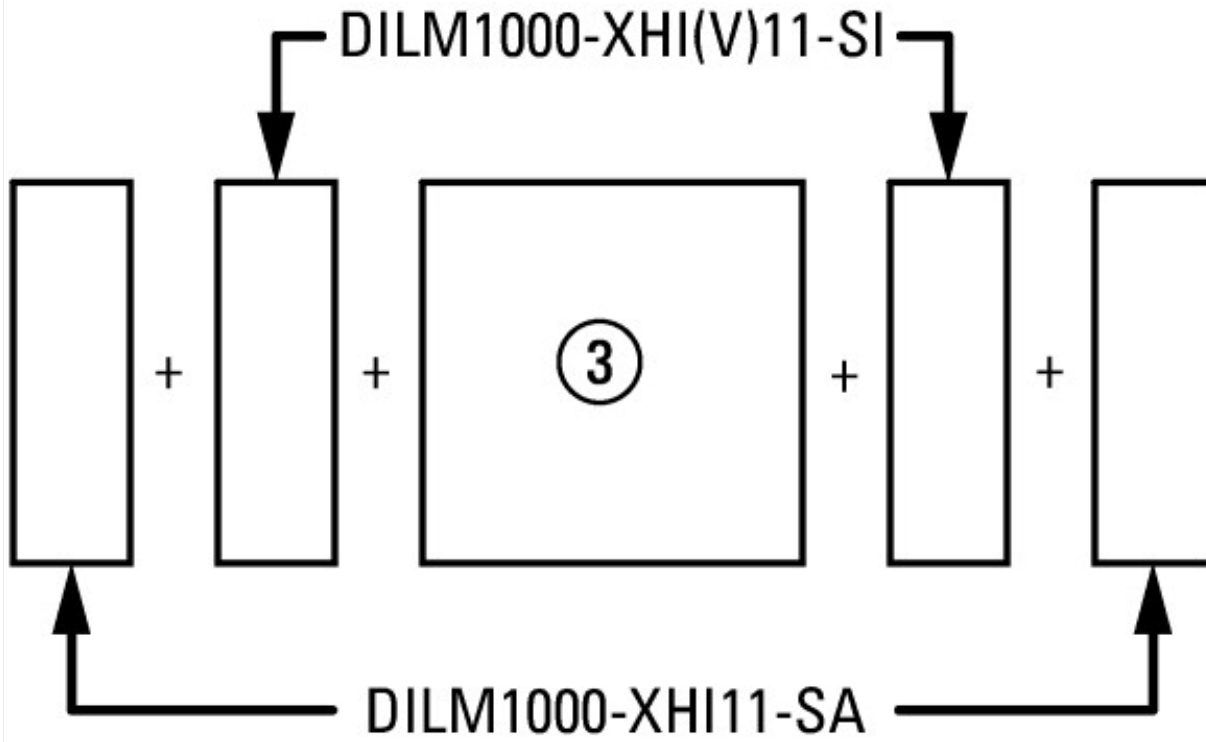

on the side: 2 x DILM1000-XHI(V)11-SI; 2 x DILM1000-XHI11-SA

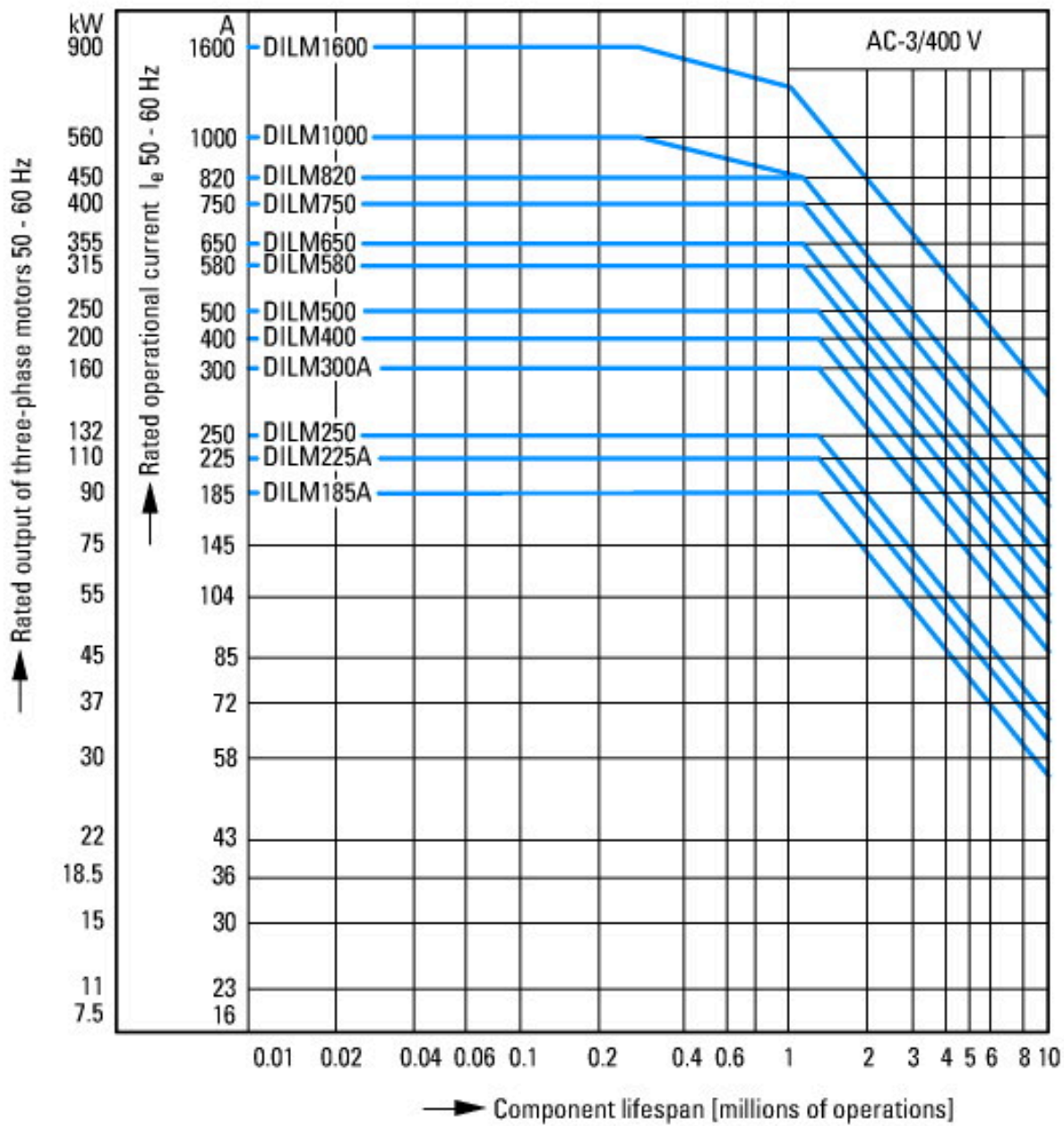

Normal switching duty  
 Normal AC induction motor  
 Operating characteristics  
 Switch on: from stop  
 Switch off: during run  
 Electrical characteristics:  
 Switch on: up to 6 x Rated motor current  
 Switch off: up to 1 x Rated motor current  
 Utility category  
 100 % AC-3  
 Typical Applications  
 Compressors  
 Lifts  
 Mixers  
 Pumps  
 Escalators  
 Agitators  
 fan  
 Conveyor belts  
 Centrifuges  
 Hinged flaps  
 Bucket-elevator  
 Air-conditioning systems  
 General drives for manufacturing and processing machines



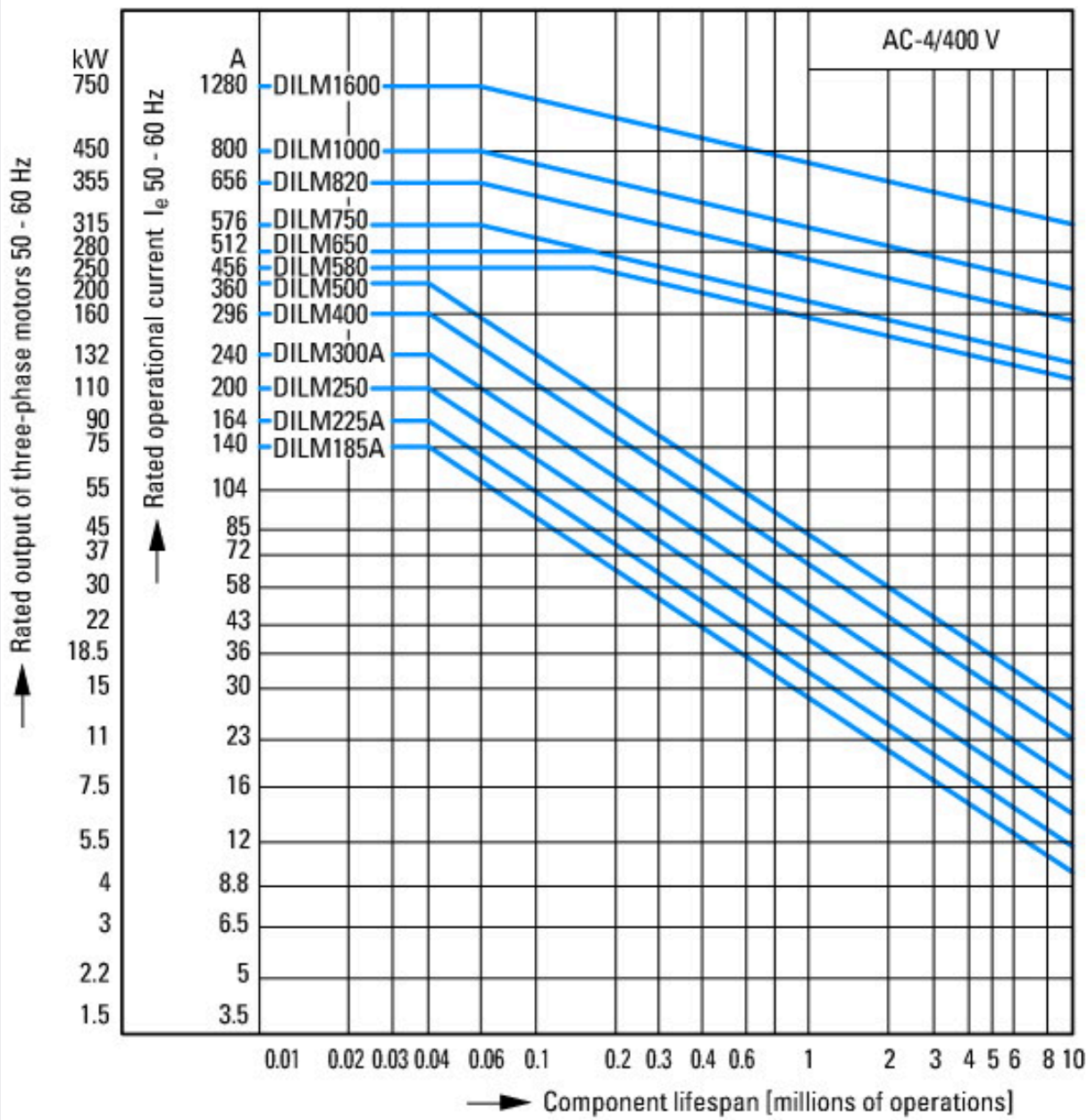

- Extreme switching duty
- Squirrel-cage motor
- Operating characteristics
- Inching, plugging, reversing
- Electrical characteristics
- Make: up to 6 x rated motor current
- Break: up to 6 x rated motor current
- Utilization category
- 100 % AC-4
- Typical applications
- Printing presses
- Wire-drawing machines
- Centrifuges
- Special drives for manufacturing and processing machines



Switching conditions for 3 pole, non-motor loads  
 Operating characteristics  
 Non inductive and slightly inductive loads  
 Electrical characteristics  
 Switch on: 1 x rated operational current  
 Switch off: 1 x rated operational current  
 Utilization category  
 100 % AC-1  
 Typical examples of application  
 Electric heat

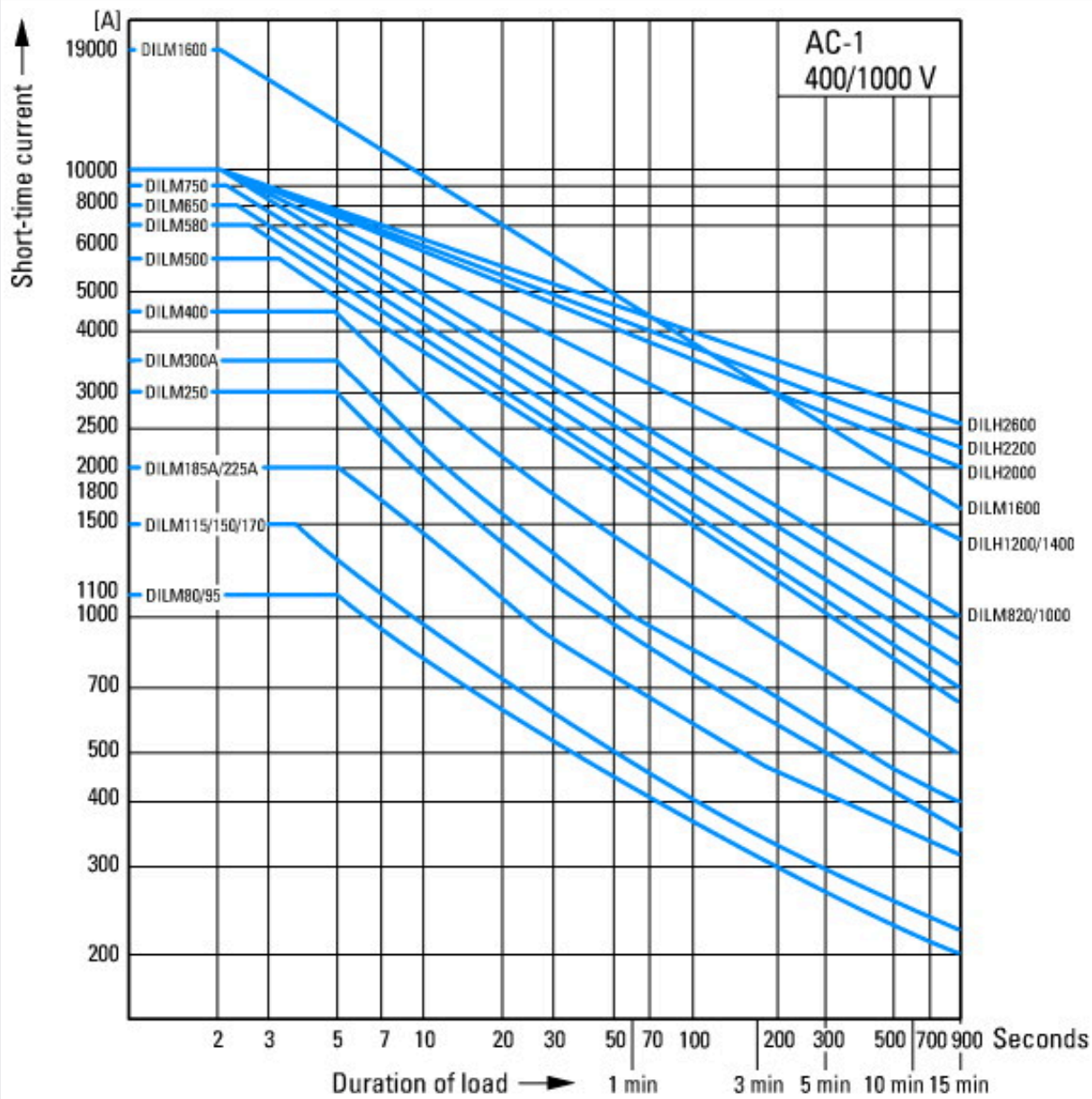

Short-time loading, 3-pole  
Time interval between two loading cycles: 15 minutes

## Dimensions

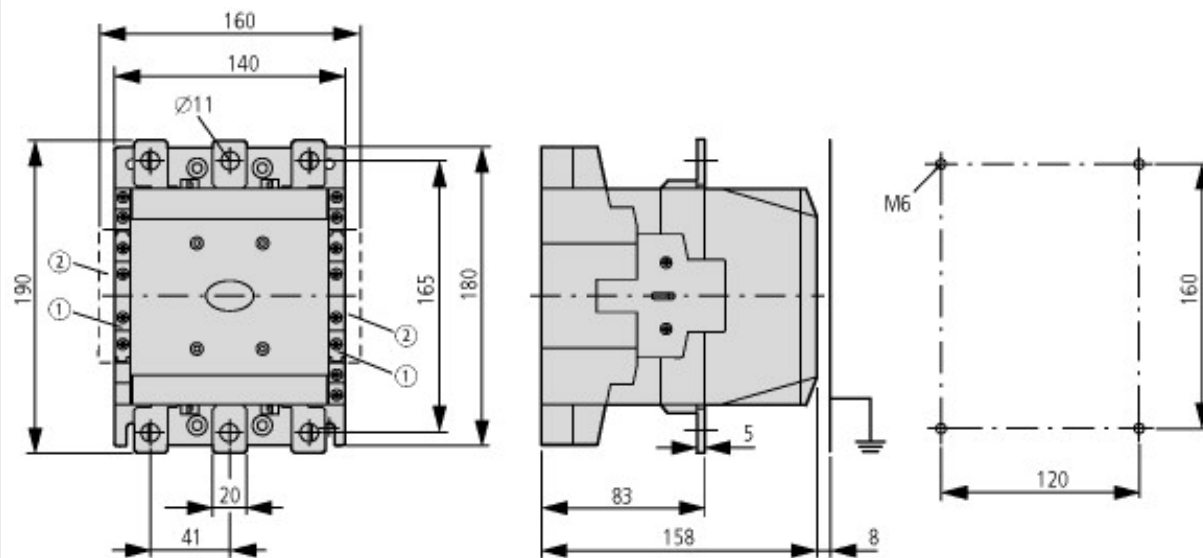

- ① DILM1000-XHI(V)11-SI
- ② DILM1000-XHI11-SA

## Additional product information (links)

IL03406001Z Contactors	
IL03406001Z Contactors	<a href="https://es-assets.eaton.com/DOCUMENTATION/AWA_INSTRUCTIONS/IL03406001Z2018_04.pdf">https://es-assets.eaton.com/DOCUMENTATION/AWA_INSTRUCTIONS/IL03406001Z2018_04.pdf</a>
Motor starters and "Special Purpose Ratings" for the North American market	<a href="http://www.eaton.eu/ecm/groups/public/@pub/@europe/@electrical/documents/content/pct_3258146.pdf">http://www.eaton.eu/ecm/groups/public/@pub/@europe/@electrical/documents/content/pct_3258146.pdf</a>
Switchgear of Power Factor Correction Systems	<a href="http://www.moeller.net/binary/ver_techpapers/ver934en.pdf">http://www.moeller.net/binary/ver_techpapers/ver934en.pdf</a>
X-Start - Modern Switching Installations Efficiently Fitted and Wired Securely	<a href="http://www.moeller.net/binary/ver_techpapers/ver938en.pdf">http://www.moeller.net/binary/ver_techpapers/ver938en.pdf</a>
Mirror Contacts for Highly-Reliable Information Relating to Safety-Related Control Functions	<a href="http://www.moeller.net/binary/ver_techpapers/ver944en.pdf">http://www.moeller.net/binary/ver_techpapers/ver944en.pdf</a>
Effect of the Cable Capacitance of Long Control Cables on the Actuation of Contactors	<a href="http://www.moeller.net/binary/ver_techpapers/ver949en.pdf">http://www.moeller.net/binary/ver_techpapers/ver949en.pdf</a>
Switchgear for Luminaires	<a href="http://www.moeller.net/binary/ver_techpapers/ver955en.pdf">http://www.moeller.net/binary/ver_techpapers/ver955en.pdf</a>
Standard Compliant and Functionally Safe Engineering Design with Mechanical Auxiliary Contacts	<a href="http://www.moeller.net/binary/ver_techpapers/ver956en.pdf">http://www.moeller.net/binary/ver_techpapers/ver956en.pdf</a>
The Interaction of Contactors with PLCs	<a href="http://www.moeller.net/binary/ver_techpapers/ver957en.pdf">http://www.moeller.net/binary/ver_techpapers/ver957en.pdf</a>
Busbar Component Adapters for modern Industrial control panels	<a href="http://www.moeller.net/binary/ver_techpapers/ver960en.pdf">http://www.moeller.net/binary/ver_techpapers/ver960en.pdf</a>