

MP5S/MP5Y/MP5W/MP5M Series

Features

- 13 kinds of various operation modes :
 Revolution, speed, frequency, absolute ratio, passing time, error ratio, cycle, density, passing speed, error, time width, length measurement, time difference, interval, multiplication (MP5M Series have 11 operation modes)
- Various output function :
 Relay output, NPN/PNP open collector output, low speed serial output, BCD output, PV transmission, RS485 communication output
- Various functions :
 Prescale function, data monitoring function, hysteresis function, peak value monitoring function, monitoring delay function, auto zero time setting function, lock setting function, display period delay function
- Max. display range : -19999 to 99999 (MP5M : 0 to 99999)
- Various display units : rpm, rps, Hz, kHz, sec, min, m, mm, mm/s, m/s, m/min, m/h, l/s, l/min, l/h, %, counts, etc.
- Selectable voltage input (PNP) or no voltage input (NPN)
- 50kHz high speed response



! Please read "Caution for your safety" in operation manual before using.



Ordering information

MP 5 S - 4 N

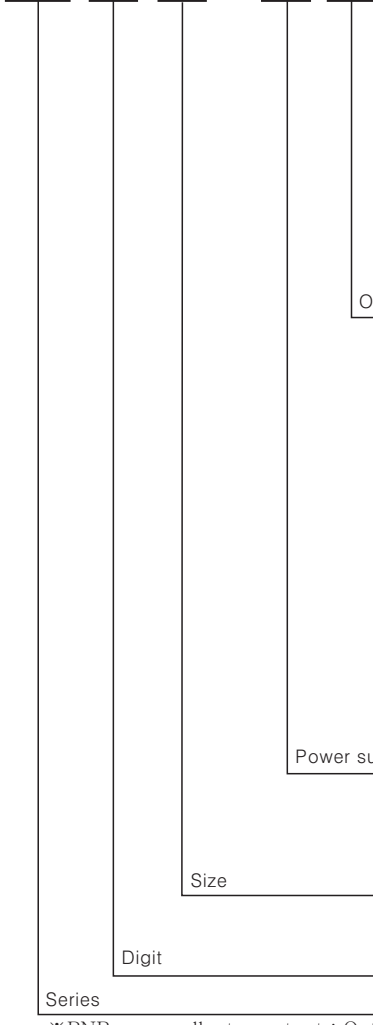



		Main output(Comparative value output)	Sub output(Display value output)	
S type	N	Indicator	X	
	Y type	N	Indicator	X
		1	NPN open collector quintuple output	X
		2	PNP open collector quintuple output	X
		3	Indicator	BCD Dynamic
W type	4	Indicator	PV transmission output(DC4-20mA)	
	5	Indicator	RS485 communication output	
	N	Indicator	X	
	A	Five relay(HH, H, GO, L, LL)	X	
	1	Triple relay(H, GO, L)	X	
	2	NPN open collector quintuple output	BCD Dynamic	
	3	PNP open collector quintuple output	BCD Dynamic	
	4	NPN open collector quintuple output	PV transmission output(DC4-20mA)	
	5	PNP open collector quintuple output	PV transmission output(DC4-20mA)	
	6	NPN open collector quintuple output	Low speed serial output	
M type	7	PNP open collector quintuple output	Low speed serial output	
	8	NPN open collector quintuple output	RS485 communication output	
	9	PNP open collector quintuple output	RS485 communication output	
	N	Indicator	X	
	1	Relay single(High-limit) output + NPN open collector output	X	
(★1)	2	Relay dual(High/Low-limit) output + NPN open collector output	X	
	2	12VDC		
	4	100-240VAC 50/60Hz		
※(★1) Low voltage type is only for MP4S, MP5Y, MP5W Series.				
	S	DIN W48×H48mm		
	Y	DIN W72×H36mm		
	W	DIN W96×H48mm		
	M	DIN W72×H72mm		
	5	99999(5 Digit)		
	MP	Pulse meter		

※PNP open collector output : Option

Pulse(Rate) Meter

■ Specifications(MP5S/MP5Y/MP5W Series)

Series	MP5S-4N	MP5Y-2□	MP5Y-4□	MP5W-2□	MP5W-4□
Display method	7 Segment LED display (Zero blanking type)				
Character size	W4 × H8mm	W6.8 × H13.8mm			
Max. indication	-19999 to 99999				
Power supply	100-240VAC 50/60Hz	12VDC	100-240VAC 50/60Hz	12VDC	100-240VAC 50/60Hz
Allowable operation voltage	Allowable operation voltage : 90 to 110%				
Power consumption	Max. 7.5VA	Max. 6W	Max. 7VA	Max. 7W	Max. 6VA
Power for external sensor	12VDC ±10%, 80mA				
Input frequency	<ul style="list-style-type: none"> • Soild-state input : Max. 50kHz(Pulse width : Each over 10μs) • Contact input : Max. 45Hz(Pulse width : Over 11ms) 				
Input level	[Voltage input] High : 4.5-24VDC, Low : 0-1.0VDC, Input impedance : 4.5kΩ [No-voltage input] Impedance at short-circuit : Max. 300Ω, Residual voltage : Max. 1V Impedance at open-circuit : Min. 100kΩ				
Measuring range	<ul style="list-style-type: none"> • Mode F1, F2, F7, F8, F9, F10 : 0.0005Hz to 50kHz • Mode F3 : 0.02s to 3,200s • Mode F4, F5, F6 : 0.01s to 3,200s • Mode F11, F12, F13 : 0 to 4 × 10⁹ Count 				
Measuring accuracy (23 ±5℃)	<ul style="list-style-type: none"> • Mode F1, F2, F7, F8, F9, F10 : F.S. ±0.05% rdg ±1Digit • Mode F3, F4, F5, F6 : F.S. ±0.01% rdg ±1Digit 				
Display period	0.05 / 0.5 / 1 / 2 / 4 / 8sec.(It is same with period of output update.)				
Operation mode	Number of revolution/Speed/Frequency (F1), Passing speed(F2), Cycle(F3), Passing time (F4), Time width(F5), Time difference(F6), Absolute ratio(F7), Error ratio(F8), Density (F9), Error (F10), Length measurement (F11), Interval (F12), Multiplication (F13) *Refer to M-19 to 22 for the operation mode.				
Prescale function	Direct input method(0.0001 × 10 ⁻⁹ to 9.9999 × 10 ⁹)				
Hysteresis	(Note1)	0 to 9999			
Other functions	<ul style="list-style-type: none"> • Lock setting function • Auto-Zero time setting function • Time unit selection function • Peak value monitoring function • Memory protection function (Mode F13 applied only) 	<ul style="list-style-type: none"> • Lock setting function • Monitoring delay function • Auto-zero time setting function • Current output range selection(Current output type only) • Comparative output function(HH, H, GO, L, LL) • Time unit selection function • Deviation memory function(F output mode applied only) • Peak value monitoring function • Remote/Local switching function (Communication output type only) • Data bank switching function (Note2) • Memory protection function(Mode F13 applied only) 			
Main output	Triple relay	————	————	250VAC 3A resistive load 3a	
	Quintuple relay				
	NPN Open collector (Quintuple)			12-24VDC 30mA Max.	
	PNP Open collector (Quintuple)			12-24VDC 20mA Max.	
Sub output	BCD Dynamic	————	NPN Open collector 12-24VDC 30mA Max.		NPN Open collector 12-24VDC 20mA Max.
	Low speed serial output	————	————		
	PV transmission	————	DC4-20mA Load 600Ω Max. (Response time : Max. 800ms)		DC4-20mA Load 600Ω Max.
	RS485 communication	————	32 channels, Mutual direction communication function		
Memory protection	Non-volatile memory (Input : Min. 100,000 times)				
Insulation resistance	Min. 100MΩ (at 500VDC megger) Between charge part and non-charge part				
Dielectric strength	2000VAC 60Hz 1minute (Between terminals of AC power and case, Between terminals of AC power and measuring input terminals)				
Impulse noise strength	±2000VAC the square wave noise (pulse width : 1μs) by the noise simulator, repeat frequency 60Hz				
Vibration	Mechanical	0.75mm amplitude at frequency of 10 ~55Hz in each of X, Y, Z directions for 2 hour			
	Malfunction	0.5mm amplitude at frequency of 10 to 55Hz in each of X, Y, Z directions for 10 minutes			
Shock	Mechanical	300m/s ² (30G) in X, Y, Z directions for 3 times			
	Malfunction	100m/s ² (10G) in X, Y, Z directions for 3 times			
Relay life cycle	Malfunction	————	Min. 10,000,000 times		
	Mechanical	————	Min. 100,000 times (250VAC 3A load current)		
Ambient temperature	-10 to 50℃ (at non-freezing status)				
Storage temperature	-20 to 60℃ (at non-freezing status)				
Ambient humidity	35 to 85%RH				
Approval	CE  US	————	CE  US	————	CE  US
Unit weight	Approx. 130g	Approx. 135g		Approx. 230g	

* **(Note1)** The hysteresis setting range is changed by the setting position of decimal point. (Refer to M-25 for hysteresis function.)

* **(Note2)** Data bank switching function is in MP5W series only.

(A) Photo electric sensor
(B) Fiber optic sensor
(C) Door/Area sensor
(D) Proximity sensor
(E) Pressure sensor
(F) Rotary encoder
(G) Connector/Socket
(H) Temp. controller
(I) SSR/Power controller
(J) Counter
(K) Timer
(L) Panel meter
(M) Tacho/Speed/Pulse meter
(N) Display unit
(O) Sensor controller
(P) Switching power supply
(Q) Stepping motor & Driver & Controller
(R) Graphic/Logic panel
(S) Field network device
(T) Production stoppage models & replacement

MP5S/MP5Y/MP5W/MP5M Series

Specifications(MP5M Series)

Model	MP5M-4N	MP5M-41	MP5M-42
	Indicator	High-limit setting type	High/Low-limit setting type
Display method	7 Segment LED display (Zero blanking), Character size : W4 X H8mm		
Max. indication	0.0001 to 99999		
Power supply	100-240VAC 50/60Hz		
Allowable operation voltage	Allowable operation voltage: 90 to 110%		
Power consumption	Approx. 7.5VA(240VAC)	Approx. 8VA(240VAC)	
Power for external sensor	12VDC \pm 10%, 80mA		
Input frequency	<ul style="list-style-type: none"> Solid-state input : Max. 50kHz(pulse width : over 10μs) Contact input : Max. 45Hz(pulse width:over 11ms) 		
Input level	[Voltage input] High : 4.5-24VDC, Low : 0-1.0VDC, Input impedance : 4.5k Ω [No-voltage input] Impedance at short-circuit : Max. 300 Ω , Residual voltage : Max. 1V Impedance at open-circuit : Min. 100k Ω		
Measuring range	<ul style="list-style-type: none"> Mode F1, F2, F7, F8 : 0.0005Hz to 50kHz Mode F3 : 0.02s to 3,200s Mode F4, F5, F6 : 0.01s to 3,200s Mode F9, F10, F11 : 0 to 4 \times 10⁹ Count 		
Measuring accuracy (23 \pm 5 $^{\circ}$ C)	<ul style="list-style-type: none"> Mode F1, F2, F7, F8 : F.S. \pm0.05% rdg \pm1Digit Mode F3, F4, F5, F6 : F.S. \pm0.01% rdg \pm1Digit 		
Display period	0.05 / 0.5 / 1 / 2 / 4 / 8sec.(It is same with period of output update.)		
Operation mode	Number of revolution/Speed/Frequency (F1), Passing speed (F2), Cycle (F3), Passing time (F4), Time width (F5), Time difference (F6), Absolute ratio (F7), Density (F8), Length measurement (F9), Interval (F10), Multiplication (F11) ※Refer to M-19 to 22 for operation mode.		
Prescale function	Direct input method(0.0001 \times 10 ⁻⁹ to 9.9999 \times 10 ⁹)		
Hysteresis	————	(Note1) 0 to 9999	
Other function	<ul style="list-style-type: none"> Lock setting function Auto-Zero time setting function Time unit selection function Peak value monitoring function Memory protection function (Mode F11 applied only) 	<ul style="list-style-type: none"> Lock setting function Monitoring delay function Auto-Zero time setting function Time unit selection function Peak value monitoring function Memory protection function (Mode F11 applied only) High-limit output function(H) 	<ul style="list-style-type: none"> Lock setting function Monitoring delay function Auto-Zero time setting function Time unit selection function Peak value monitoring function Memory protection function (Mode F11 applied only) Comparative output function(H, L) Output mode selection function (S, H, L, B, I, F) Deviation memory function (F output mode applied only)
Main output	Relay output	250VAC 3A resistive load 1c	250VAC 3A resistive load 1a \times 2
	NPN Open Collector	30VDC 100mA Max.	30VDC 100mA Max. \times 2
Memory protection	Non-volatile memory (Input : Min. 100,000 times)		
Approval			
Unit weight	Approx. 275g	Approx. 310g	Approx. 330g

※MP5S, MP5Y, MP5W have same function.

※(Note1) The hysteresis setting range is changed by the setting position of decimal point. (Refer to M-25 Page, hysteresis function.)

Connections

MP5M Series

MP5M-4N(Indicator)

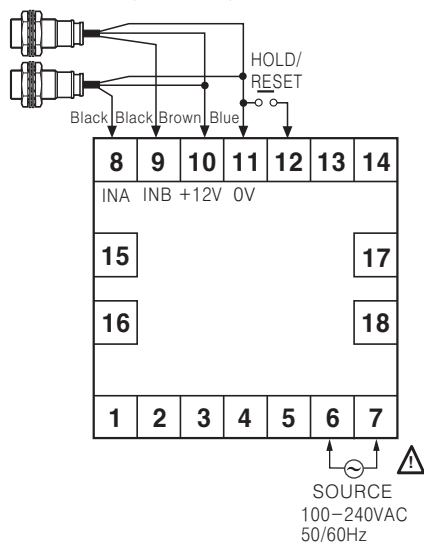

MP5M-41(High-limit setting type)

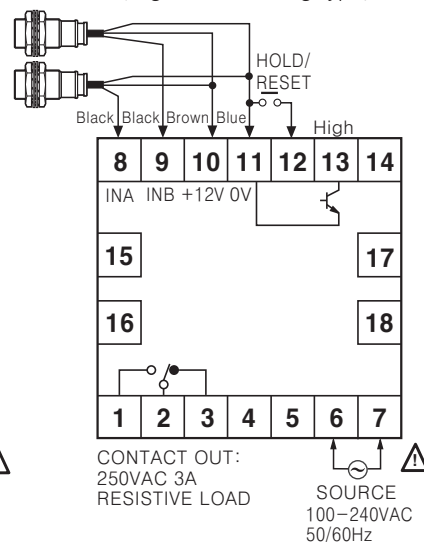

MP5M-42(High/Low-limit setting type)

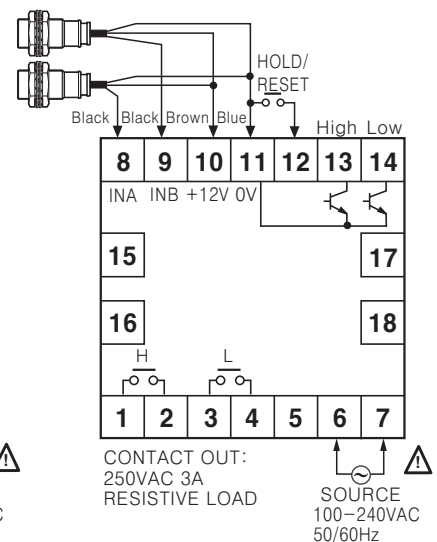

Pulse(Rate) Meter

Connections

MP5S Series

MP5S-4N(Indicator)

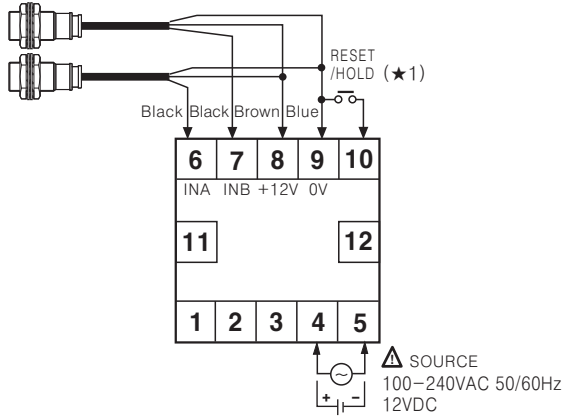

※(★1) It is used for RESET terminal when an operation mode is F13. (Refer to M-19~22 for operation mode.)

MP5Y Series

MP5Y-□N(Indicator)

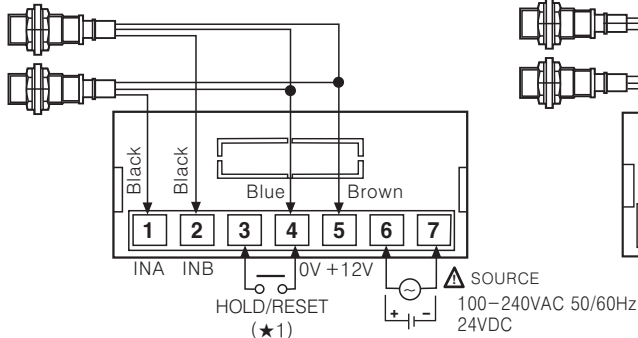

MP5Y-□4 to □5(Main/Sub output type)

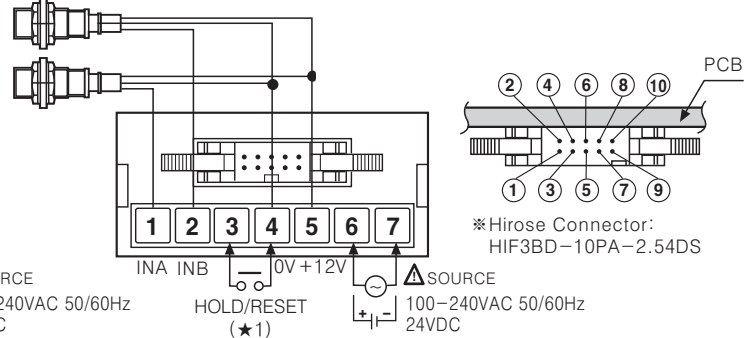

※(★1) It is used for RESET terminal when an operation mode is F13. (Refer to M-19~22 for operation mode.)

Main output(Connector)

MP5Y-□1(NPN open collector output)

MAIN OUT
 (NPN OPEN COLLECTOR:12-24VDC Max. 30mA)

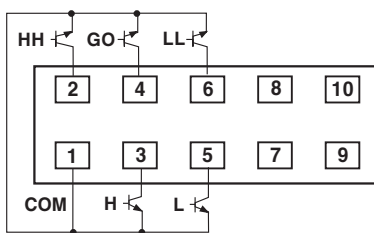

MP5Y-□2(PNP open collector output)

MAIN OUT
 (PNP OPEN COLLECTOR:12-24VDC Max. 30mA)

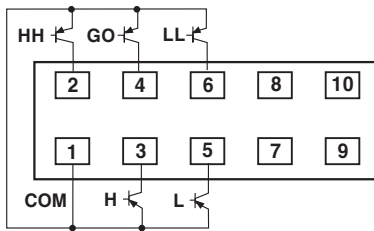

Sub output(Connector)

MP5Y-□3(BCD dynamic output)

BCD OUT
 (NPN OPEN COLLECTOR:12-24VDC Max. 30mA)

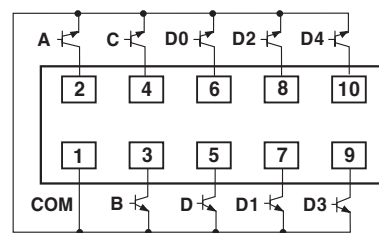

MP5Y-□4(PV transmission output)

DC4-20mA
 Load 600Ω Max.

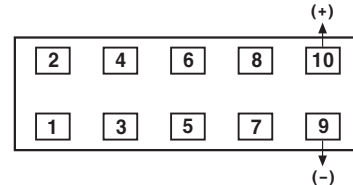

MP5Y-□5(RS485 communication output)

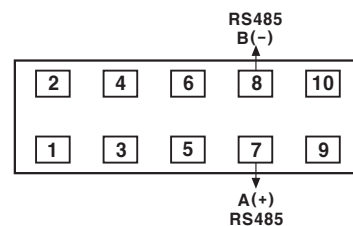

※Main output type & sub output type : Customizable

(A) Photo electric sensor

(B) Fiber optic sensor

(C) Door/Area sensor

(D) Proximity sensor

(E) Pressure sensor

(F) Rotary encoder

(G) Connector/Socket

(H) Temp. controller

(I) SSR/Power controller

(J) Counter

(K) Timer

(L) Panel meter

(M) Tacho/Speed/Pulse meter

(N) Display unit

(O) Sensor controller

(P) Switching power supply

(Q) Stepping motor & Driver & Controller

(R) Graphic/Logic panel

(S) Field network device

(T) Production stoppage models & replacement

MP5S/MP5Y/MP5W/MP5M Series

◎MP5W Series

●MP5W-□N(Indicator)

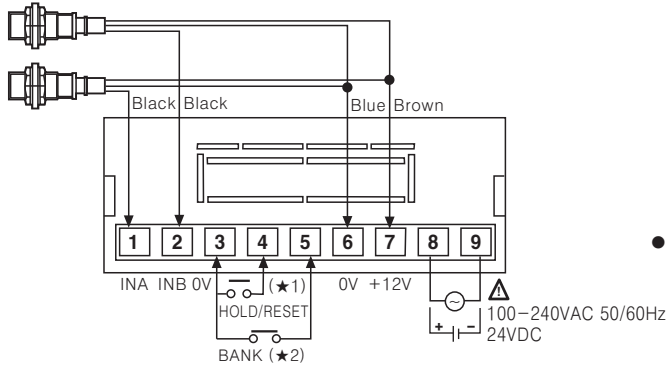

- ※(★1) It is used for RESET terminal when an operation mode is F13. (Refer to M-19~22)
- ※(★2) Refer to M-25 for BANK function.
- ※Main output type & sub output type : option

●MP5W-□A(Five relay output)

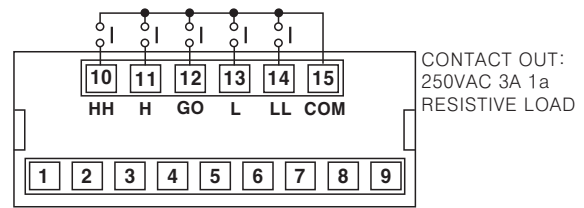

CONTACT OUT:
250VAC 3A 1a
RESISTIVE LOAD

●MP5W-□1(Triple relay output)

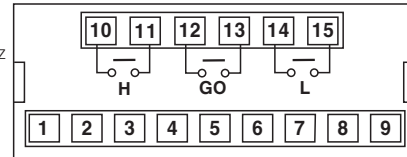

CONTACT OUT:
250VAC 3A 1a
RESISTIVE LOAD

◆Main output+Sub output(Connector)

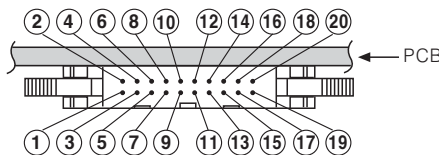
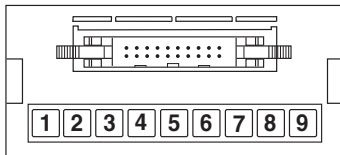

- ※Hirose connector pin header model of the unit : HIF3BA-20PA-2.54DS
- ※Contact Hirose Electric to purchase socket and wires of Hirose connector. [Socket : HIF3BA-20D-2.54R]

●MP5W-□2/ MP5W-□3(NPN/PNP open collector output + BCD output)

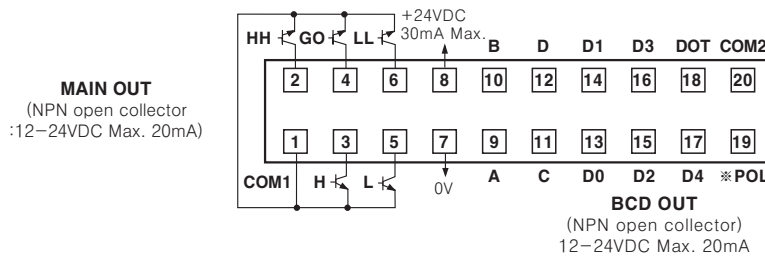

MAIN OUT
(NPN open collector
:12-24VDC Max. 20mA)

BCD OUT
(NPN open collector
12-24VDC Max. 20mA

※POL signal is on when it is - display value

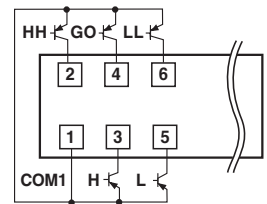

MAIN OUT
(PNP open collector
:12-24VDC Max. 20mA)

●MP5W-□4/ MP5W-□5(NPN/PNP open collector output + PV transmission output(DC4-20mA) output)

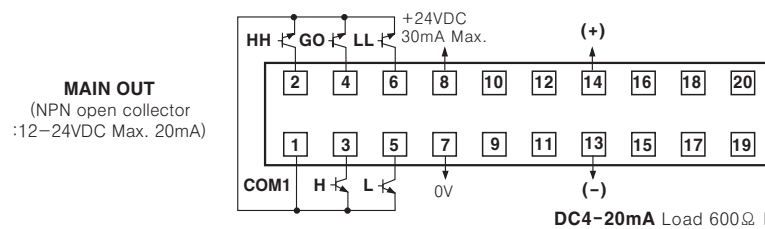

MAIN OUT
(NPN open collector
:12-24VDC Max. 20mA)

DC4-20mA Load 600Ω Max.

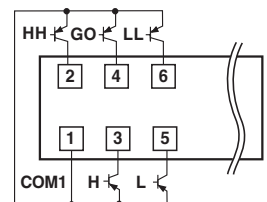

MAIN OUT
(PNP open collector
:12-24VDC Max. 20mA)

●MP5W-□6/ MP5W-□7(NPN/PNP open collector output + Low speed serial output)

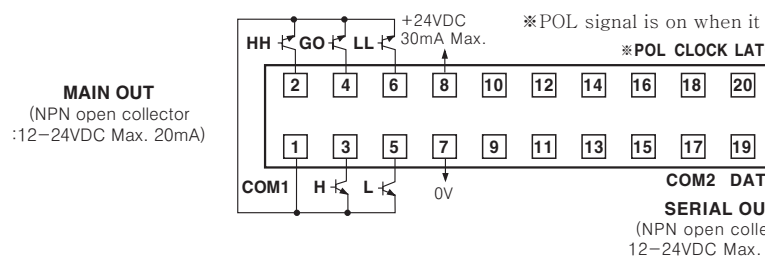

MAIN OUT
(NPN open collector
:12-24VDC Max. 20mA)

※POL signal is on when it is - display value

※POL CLOCK LATCH

SERIAL OUT
(NPN open collector
12-24VDC Max. 20mA

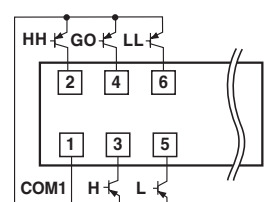

MAIN OUT
(PNP open collector
:12-24VDC Max. 20mA)

●MP5W-□8/ MP5W-□9(NPN/PNP open collector output + RS485 communication output)

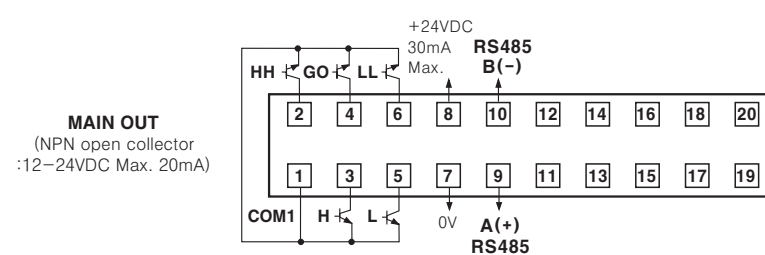

MAIN OUT
(NPN open collector
:12-24VDC Max. 20mA)

MAIN OUT
(PNP open collector
:12-24VDC Max. 20mA)

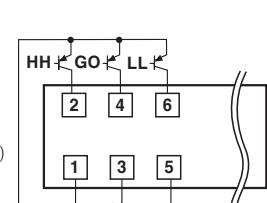

Pulse(Rate) Meter

■ Dimensions

●MP5S Series

●Bracket

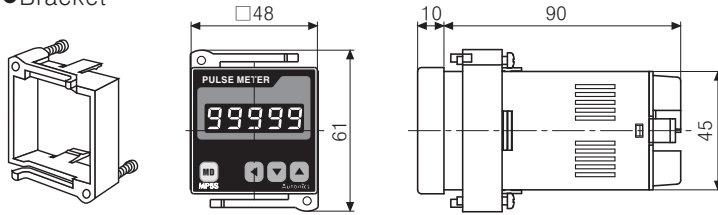

●Panel cut-out

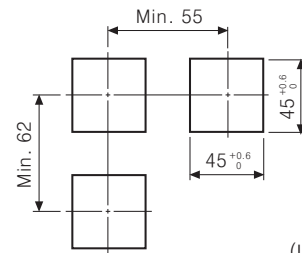

(Unit:mm)

●MP5Y Series

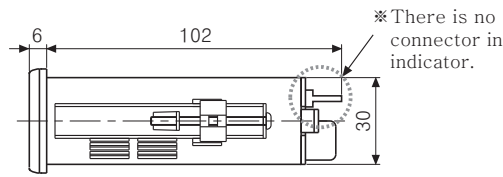
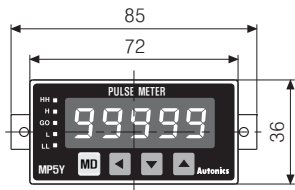

*Hirose connector : HIF3BD-10PA-2.54DS

●Panel cut-out

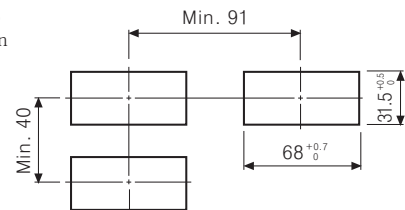

(Unit:mm)

●MP5W Series

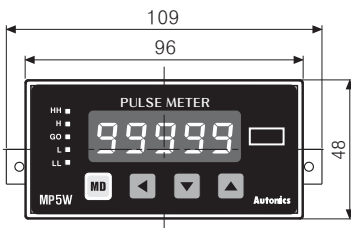

[Terminal block type]

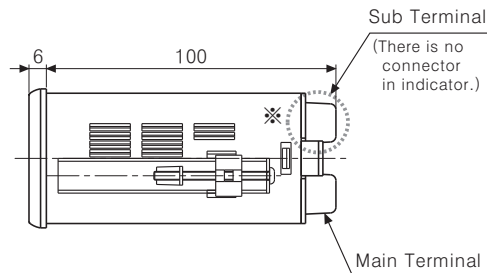

*There is no terminal block in indicator.

●Panel cut-out

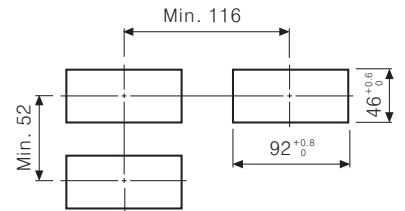

[Connector type]

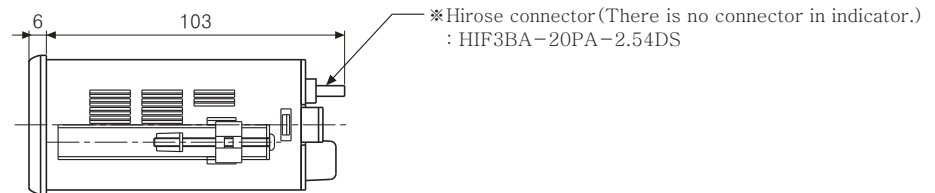

(Unit:mm)

●MP5M Series

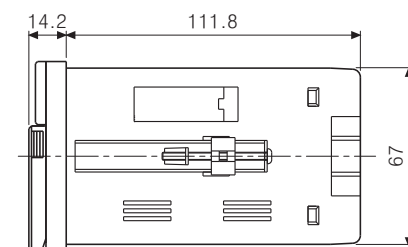
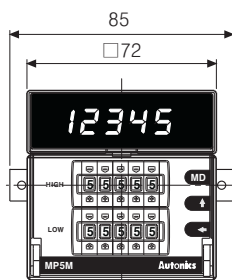

●Panel cut-out

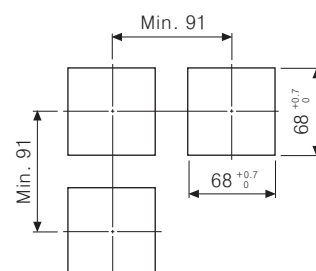

(Unit:mm)

(A)	Photo electric sensor
(B)	Fiber optic sensor
(C)	Door/Area sensor
(D)	Proximity sensor
(E)	Pressure sensor
(F)	Rotary encoder
(G)	Connector/Socket
(H)	Temp. controller
(I)	SSR/Power controller
(J)	Counter
(K)	Timer
(L)	Panel meter
(M)	Tacho/Speed/Pulse meter
(N)	Display unit
(O)	Sensor controller
(P)	Switching power supply
(Q)	Stepping motor & Driver & Controller
(R)	Graphic/Logic panel
(S)	Field network device
(T)	Production stoppage models & replacement

MP5S/MP5Y/MP5W/MP5M Series

Input specifications

Input signal

Solid-state input

- Input frequency : **50kHz Max.**
Standard duty ratio of input signal is 1:1,
ON/OFF pulse width should be over 10 μ s.
- Input voltage level : High \rightarrow 4.5–24VDC, Low \rightarrow 0–1.0VDC

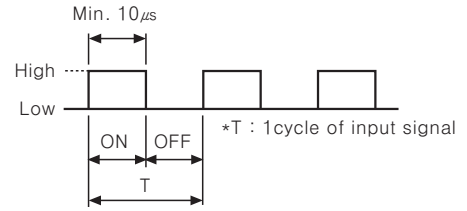

Relay contact input

- Input frequency : **45Hz Max.**
ON/OFF pulse width should be over 11ms.
- Relay contact specification : Please use a relay contact that can carry the load current (Min. 12VDC 2mA).

Input type

MP5 has NPN input and PNP input and it is able to select in Parameter group 1.

When it is NPN input type

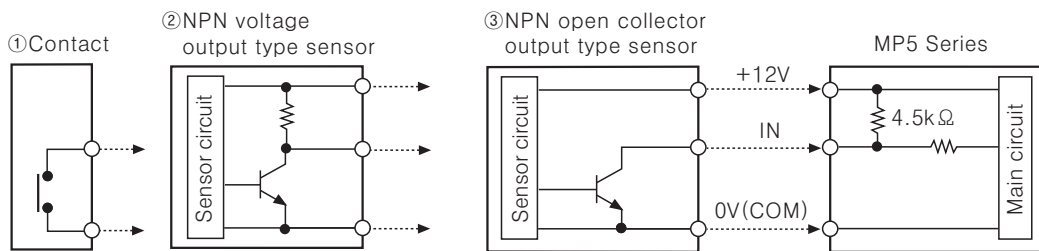

When it is PNP input type

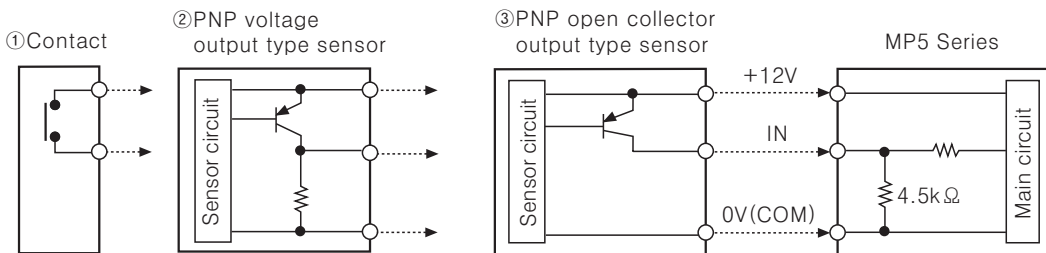

Output specifications (MP5Y/ MP5W Series)

BCD dynamic output (Negative logic)

- Output : Display value
- Output signal :
BCD Data (A, B, C, D, DOT) \leftarrow A : Lowest bit
Dot : Highest bit
Digit Data (D0, D1, D2, D3, D4) \leftarrow D0 : Lowest digit
D4 : Highest digit

※ There is no DOT data output in MP5Y-□3, therefore decimal point should be mark in first display plate.

- Output type : NPN open collector
- Rated load voltage : 12–24VDC
- Max. load current : 30mA (MP5Y)/ 20mA (MP5W)

Ex) When BCD dynamic output is 125.89

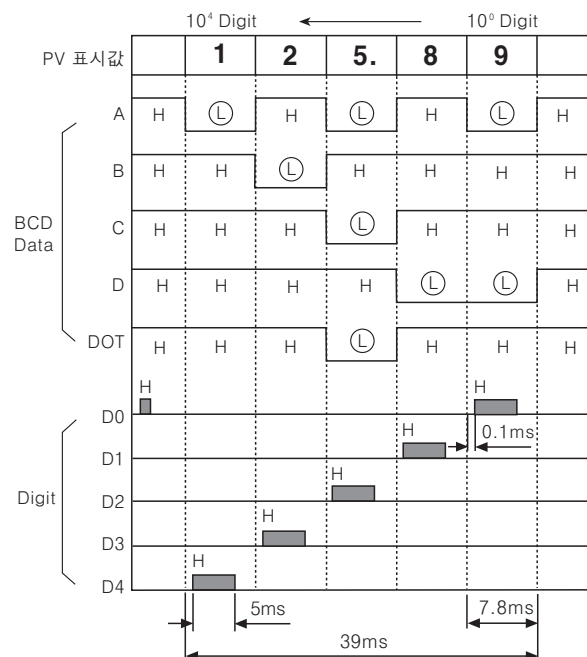

Pulse(Rate) Meter

◎Low speed serial output(Negative logic)

- Output : Display value
- Output signal : Clock, Data, Latch
- Clock cycle : 50Hz
- Output CLK bit : 25 bit
- Output Data bit : 25 bit
- Output form : NPN open collector
- Rated load voltage : 12-24VDC
- Max. load current : 30mA(MP5Y)/ 20mA(MP5W)

●Serial transmission time diagram

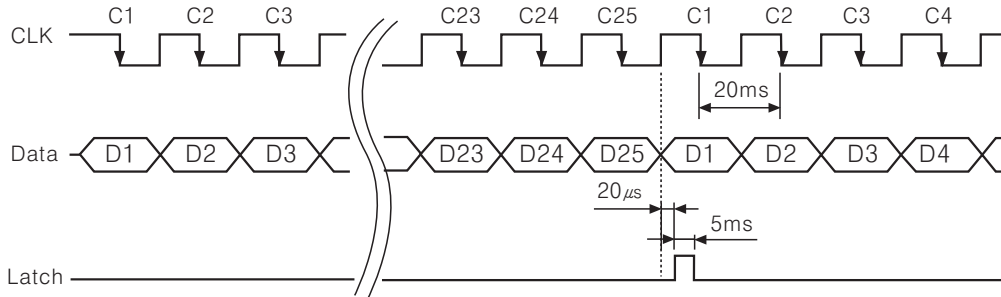

●Data output order when it is serial transmission

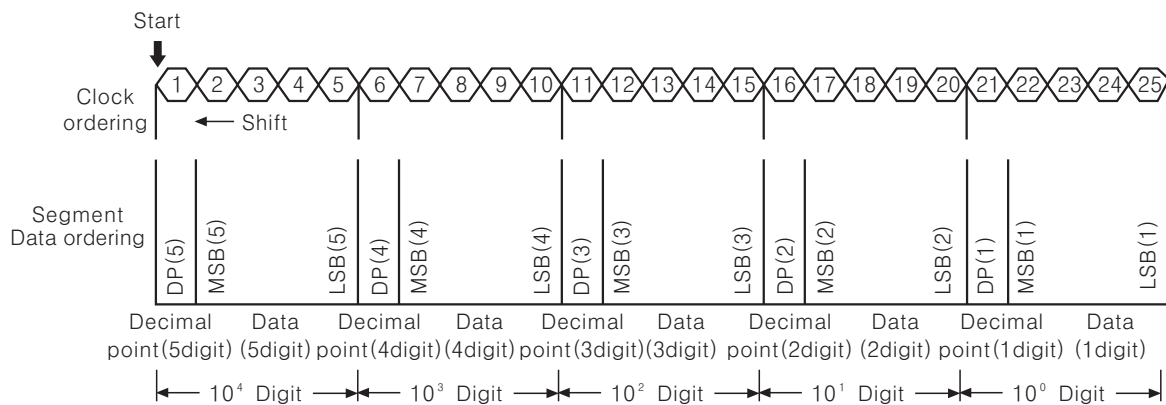

◎PV transmission output(DC4-20mA)

- Application : Transmit the measured value
- Function : This function is to transmit DC4-20mA converted from measured display value between High limit output (FS-H) and Low limit (FS-L).
- Range of High/Low limit output setting
 - High limit setting range (FS-H)
 - From min. to max within range of measurement
 - Low limit setting range (FS-L)
 - From min. to max within range of measurement
 - (FS-H \geq FS-L + 1 digit)
- Load resistance : Max. 600Ω
- Resolution : 8000 division

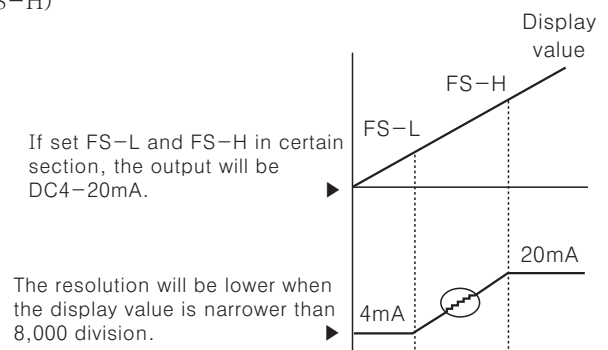

◎RS485 communication output

- Address : 0 to 99 address
 - Transmission speed(Baud rate) : 2400/4800/9600 bps
 - Transmission code : ASCII
 - Parity Bit : No
 - Data Bit : 8 Bit
 - Stop Bit : 1 Bit
 - Communication items
 - MP5W ← PC : Comparative value of each bank data, prescale value and peak value, RESET control
 - MP5W → PC : Comparative value of each bank data, prescale value and peak value, display value
- ※Refer to M-26 for communication data.

(A)	Photo electric sensor
(B)	Fiber optic sensor
(C)	Door/Area sensor
(D)	Proximity sensor
(E)	Pressure sensor
(F)	Rotary encoder
(G)	Connector/Socket
(H)	Temp. controller
(I)	SSR/Power controller
(J)	Counter
(K)	Timer
(L)	Panel meter
(M)	Tacho/Speed/Pulse meter
(N)	Display unit
(O)	Sensor controller
(P)	Switching power supply
(Q)	Stepping motor & Driver & Controller
(R)	Graphic/Logic panel
(S)	Field network device
(T)	Production stoppage models & replacement

MP5S/MP5Y/MP5W/MP5M Series

Parameter group chart for operation mode

- Parameter display are different according to each operation mode, refer to "Parameter" part.
- "○": When select the operation mode, the parameter will be displayed.
- "X": When select the operation mode, the parameter will not be displayed.
- "◎": It is only able to set $nPn.h.F$ or $Pn.P.h.F$ for $ln-b$ sensor type in F11, F12, F13 of operation mode.

Parameter display		F1	F2	F3	F4	F5	F6	F7	F8	F9	F10	F11	F12	F13
Parameter group 0	$PSt.hh$	○	○	○	○	○	○	○	○	○	○	○	○	○
	$PSt.h$	○	○	○	○	○	○	○	○	○	○	○	○	○
	$PSt.L$	○	○	○	○	○	○	○	○	○	○	○	○	○
	$PSt.LL$	○	○	○	○	○	○	○	○	○	○	○	○	○
	$h.PEY$	○	○	○	○	○	○	○	○	○	○	○	○	X
	$L.PEY$	○	○	○	○	○	○	○	○	○	○	○	○	X
Parameter group 1	$\bar{n}odE$	○	○	○	○	○	○	○	○	○	○	○	○	○
	$ln-R$	○	○	○	○	○	○	○	○	○	○	○	○	○
	$ln-b$	X	○	X	X	X	○	○	○	○	○	◎	◎	◎
	$out-t$	○	○	○	○	○	○	○	○	○	○	○	○	X
	hYS	○	X	X	X	X	X	○	○	○	○	X	X	X
	$\bar{G}uAr.d \leftrightarrow F.dEFY$	○	○	○	○	○	○	○	○	○	○	○	○	X
	$\bar{G}uAr.d \leftrightarrow StAr.t$	○	○	○	○	○	○	○	○	○	○	○	○	X
	$Ruto.R$	○	X	X	○	X	X	○	○	○	○	X	X	X
	$Ruto.b$	X	X	X	X	X	X	○	○	○	○	X	X	X
$\bar{n}E\bar{n}o$	X	X	X	X	X	X	X	X	X	X	X	X	○	
Parameter group 2	$P.bAnY$	○	○	○	○	○	○	○	○	○	○	○	○	○
	dot	○	○	X	X	X	X	○	○	○	○	○	○	○
	$t.unT$	X	X	○	○	○	○	X	X	X	X	X	X	X
	$PSt.hh$	○	○	○	○	○	○	○	○	○	○	○	○	○
	$PSt.h$	○	○	○	○	○	○	○	○	○	○	○	○	○
	$PSt.L$	○	○	○	○	○	○	○	○	○	○	○	○	○
	$PSt.LL$	○	○	○	○	○	○	○	○	○	○	○	○	○
	$PSC.RH$	○	○	X	○	X	X	○	○	○	○	○	○	○
	$PSC.RY$	○	○	X	○	X	X	○	○	○	○	○	○	○
	$PSC.b.H$	X	X	X	X	X	X	○	○	○	○	X	X	X
	$PSC.b.Y$	X	X	X	X	X	X	○	○	○	○	X	X	X
	$dI SPt$	○	X	X	X	X	X	○	○	○	○	X	X	X
Parameter group 3	$FS-h$	When it is PV transmission output, it operates in all mode.												
	$FS-L$	When it is PV transmission output, it operates in all mode.												
	$Addr$	When it is RS485 communication output, it operates in all mode.												
	bPS	When it is RS485 communication output, it operates in all mode.												
	$rE\bar{n}ot$	When it is RS485 communication output, it operates in all mode.												
	LoC	○	○	○	○	○	○	○	○	○	○	○	○	○

Operation mode by each series

Operation mode	Frequency rotation speed	Passing speed	Cycle	Passing time	Time width	Time difference	Absolute ratio	Error ratio	Density	Error	Length measurement	Interval	Multiplication
MP5S/MP5Y/MP5W	F1	F2	F3	F4	F5	F6	F7	F8	F9	F10	F11	F12	F13
MP5M	F1	F2	F3	F4	F5	F6	F7	X	F8	X	F9	F10	F11

Pulse(Rate) Meter

Parameter group chart for model

- The parameter has different mode according to each model, therefore refer to "Parameter group chart of operation mode" and "Parameter".
- ○ : When selecting the operation mode, the parameter will be displayed.
- X : When selecting the operation mode, the parameter will not be displayed.

Model	MP5S-4N MP5Y-4N MP5W-4N MP5M-4N	MP5Y-41 MP5Y-42	MP5Y-43	MP5Y-44	MP5Y-45	MP5W-41	MP5W-4A MP5W-42 MP5W-43	MP5W-44 MP5W-45	MP5W-46 MP5W-47	MP5W-48 MP5W-49	MP5M-41	MP5M-42
Parameter group 0	<i>PSt.hh</i>	X	○	X	X	X	○	○	○	○	X	X
	<i>PSt.h</i>	X	○	X	X	X	○	○	○	○	X	X
	<i>PSt.L</i>	X	○	X	X	X	○	○	○	○	X	X
	<i>PSt.LL</i>	X	○	X	X	X	○	○	○	○	X	X
	<i>h.PEY</i>	○	○	○	○	○	○	○	○	○	○	○
	<i>L.PEY</i>	○	○	○	○	○	○	○	○	○	○	○
Parameter group 1	<i>nodE</i>	○	○	○	○	○	○	○	○	○	○	○
	<i>ln-A</i>	○	○	○	○	○	○	○	○	○	○	○
	<i>ln-b</i>	○	○	○	○	○	○	○	○	○	○	○
	<i>out-t</i>	X	○	X	X	X	○	○	○	○	X	○
	<i>hYS</i>	X	○	X	X	X	○	○	○	○	○	○
	<i>GuAr.d ↔ F.dEFY</i>	X	○	X	X	X	○	○	○	○	X	○
	<i>GuAr.d ↔ StAr.t</i>	X	○	X	X	X	○	○	○	○	X	○
	<i>Auto.A</i>	○	○	○	○	○	○	○	○	○	○	○
	<i>Auto.b</i>	○	○	○	○	○	○	○	○	○	○	○
<i>nEño</i>	○	○	○	○	○	○	○	○	○	○	○	
Parameter group 2	<i>P.bAnY</i>	○	X	X	X	X	○	○	○	○	X	X
	<i>dot</i>	○	○	○	○	○	○	○	○	○	○	○
	<i>t.vnt</i>	○	○	○	○	○	○	○	○	○	○	○
	<i>PSt.hh</i>	X	○	X	X	X	○	○	○	○	X	X
	<i>PSt.h</i>	X	○	X	X	X	○	○	○	○	X	X
	<i>PSt.L</i>	X	○	X	X	X	○	○	○	○	X	X
	<i>PSt.LL</i>	X	○	X	X	X	○	○	○	○	X	X
	<i>PSC.AH</i>	○	○	○	○	○	○	○	○	○	○	○
	<i>PSC.AY</i>	○	○	○	○	○	○	○	○	○	○	○
	<i>PSC.bH</i>	○	○	○	○	○	○	○	○	○	○	○
	<i>PSC.bY</i>	○	○	○	○	○	○	○	○	○	○	○
	<i>diSPt</i>	○	○	○	○	○	○	○	○	○	○	○
Parameter group 3	<i>F5-h</i>	X	X	X	○	X	X	X	○	X	X	X
	<i>F5-L</i>	X	X	X	○	X	X	X	○	X	X	X
	<i>Addr</i>	X	X	X	X	○	X	X	X	○	X	X
	<i>bPS</i>	X	X	X	X	○	X	X	X	○	X	X
	<i>rEñot</i>	X	X	X	X	○	X	X	X	○	X	X
	<i>LoC</i>	○	○	○	○	○	○	○	○	○	○	○

※ : Data bank (*P.bAnY*) setting is available in only MP5W-□N.

Monitoring delay operation function chart by each output mode

<i>out-t</i>	<i>StAr.d</i>	<i>out-h</i>	<i>out-L</i>	<i>out-b</i>	<i>out-I</i>	<i>out-F</i>
Comparative output limit function	○	X	X	○	X	○
Starting correction timer function	○	○	○	○	○	○

- (A) Photo electric sensor
- (B) Fiber optic sensor
- (C) Door/Area sensor
- (D) Proximity sensor
- (E) Pressure sensor
- (F) Rotary encoder
- (G) Connector/Socket
- (H) Temp. controller
- (I) SSR/Power controller
- (J) Counter
- (K) Timer
- (L) Panel meter
- (M) Tacho/Speed/Pulse meter
- (N) Display unit
- (O) Sensor controller
- (P) Switching power supply
- (Q) Stepping motor & Driver & Controller
- (R) Graphic/Logic panel
- (S) Field network device
- (T) Production stoppage models & replacement

MP5S/MP5Y/MP5W/MP5M Series

Parameter

Parameter group 0

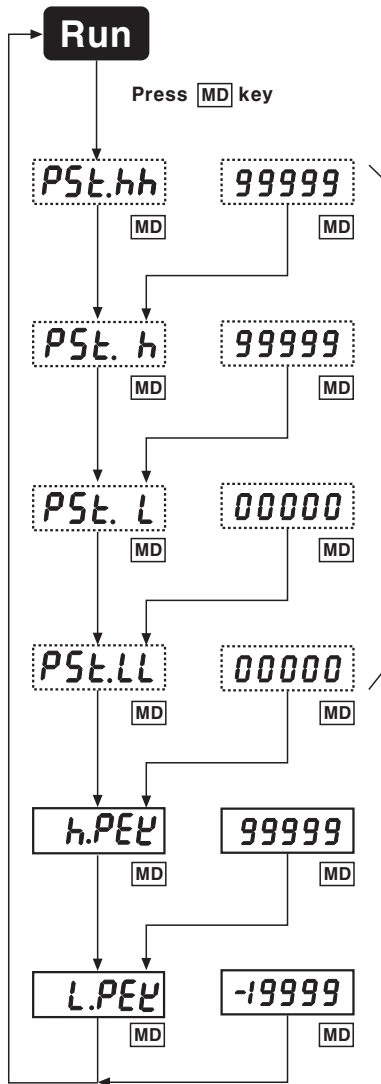

If **[MD]** key is pressed in **RUN** mode, it will advance to Parameter group 0.

Set HH comparative value. Refer to the "Setting range of comparative value by operation mode" for a setting range.
 (◀ : Shift the setting digit ▼, ▲ : Change the setting value)

Set H comparative value.
 (◀ : Shift the setting digit ▼, ▲ : Change the setting value)

(★1)
 Set L comparative value.
 (◀ : Shift the setting digit ▼, ▲ : Change the setting value)

Set L comparative value.
 (◀ : Shift the setting digit ▼, ▲ : Change the setting value)

Display High Peak value among measuring values.
 If ◀ key is pressed for 2 sec., The High Peak value will be reset and it displays a current measuring value

Display Low Peak value among measuring values.
 If ◀ key is pressed for 2 sec., The Low Peak value will be reset and it displays a current measuring value

Setting range of comparative value by operation mode

Series	Operation mode	Setting range
MP5S	F1, F2, F7, F9, F11, F12, F13	0 to 99999
	F3, F4, F5, F6	0 to Setting time range
MP5Y		
MP5W	F8, F10	-19999 to 99999
MP5M	F1, F2, F7, F8, F9, F10, F11	0 to 99999
	F3, F4, F5, F6	0 to Setting time range

※The setting range is changed by setting position of decimal point.

※If **[MD]** key is pressed in **RUN** mode, it will advance to Parameter group 0.

※When advance to Parameter group 0, parameter and set data value is flashed as 1 sec. cycle.

※(★1) • The parameter shown in dotted line is displayed only for comparative value setting type.

• If F mode is selected among output modes, it is to set H and L deviation only, therefore **[PSE.hh]** and **[PSE.LL]** parameter will not appear.

※After setting value in each parameter is changed, data will be saved by press **[MD]** key for 2sec. and return to **RUN** mode, but if any keys are untouched for 60sec. while changing data, it will return to **RUN** mode with previous set value.

• If it is not comparing value setting type, **[h.PEV]** will appear when advance to parameter group 0.

●Parameter group 1

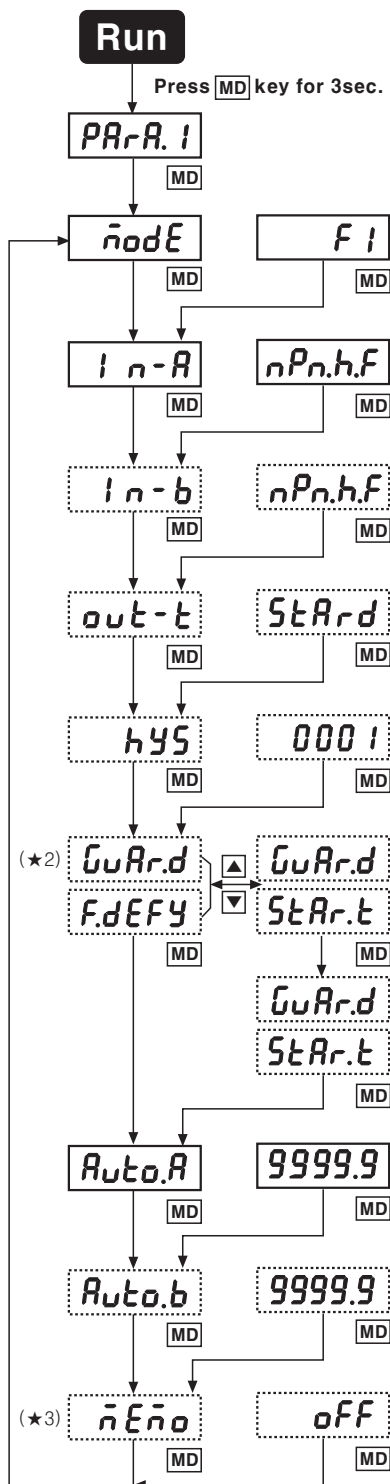

This is parameter group 1.
Display **PAR.A.1** for 2 sec and move to **nodE**.

Select operation mode.
→ **F1** → **F2** → **F3** ~ **F13** (★1)
(▼, ▲: Change the operation mode)

Set the sensor type of input A.
→ **nPn.h.F** → **nPn.L.F** → **PnP.h.F** → **PnP.L.F**
(▼, ▲: Change the)

Set the sensor type of input B.
→ **nPn.h.F** → **nPn.L.F** → **PnP.h.F** → **PnP.L.F**
(▼, ▲: Change the sensor type)

Select the output mode.
→ **StAr.d** → **out-h** → **out-L** → **out-b** → **out-I** → **out-F**
(▼, ▲: Change the output mode)

Set the hysteresis for the output .
Setting range : **0** to **9999** (The hysteresis range differs by the setting position of decimal point. See M-25 page)
(▼, ▲: Change the setting value)

Starting protection timer function(**StAr.t**) or comparative output(L, LL) limit function(**F.dEFY**)
→ **F.dEFY** → **StAr.t**
(▼, ▲: Change the setting value)

Set the protection time when it is a starting protection timer function(**StAr.t**).
setting range : **0.0** to **99.9** sec.
(◀: Move the digit ▼, ▲: Change the setting value)

Set the Auto-zero time of INA input.
Setting range : **0.1** to **9999.9** sec.
(◀: Move the digit ▼, ▲: Change the setting value)

Set the Auto-zero time of INB input.
Setting range : **0.1** to **9999.9** sec.
(◀: Move the digit ▼, ▲: Change the setting value)

It sets the memory protection.
→ **off** → **on** (**off** : Enable of memory protection,
 on : Disble of memory protection)
(▼, ▲: Change the setting value)

●Input sensor

NPN input type	
• Transistor input :	nPn.h.F
• Contact input :	nPn.L.F
PNP input type	
• Transistor input :	PnP.h.F
• Contact input :	PnP.L.F

(A)	Photo electric sensor
(B)	Fiber optic sensor
(C)	Door/Area sensor
(D)	Proximity sensor
(E)	Pressure sensor
(F)	Rotary encoder
(G)	Connector/Socket
(H)	Temp. controller
(I)	SSR/Power controller
(J)	Counter
(K)	Timer
(L)	Panel meter
(M)	Tacho/Speed/Pulse meter
(N)	Display unit
(O)	Sensor controller
(P)	Switching power supply
(Q)	Stepping motor & Driver & Controller
(R)	Graphic/Logic panel
(S)	Field network device
(T)	Production stoppage models & replacement

- ※ If **MD** key is pressed for 3 sec. in **RUN** mode, it will advance to Parameter group 1.
- ※ When advance to Parameter group 1, parameter and set data value flash as 1 sec. cycle.
- ※ The parameter shown in dotted line is not displayed by operating mode.
(Refer to M-13, "Parameter group chart for operation mode".)
- ※ (★1) MP5M type is able to select from F1 to F11.
- ※ (★2) The parameter is displayed in case of comparative value setting type only.
(Except for indicator and MP5M-41)
- ※ (★3) The selecting function of memory protection is displayed when the mode is F13(Multiplication mode).
(But, F11 mode for MP5M)
- ※ After changing setting value in each Parameter, data will be saved by press **MD** key for 2sec. and return to **RUN** mode, but if any keys are untouched for 60sec. while changing data, it will return to **RUN** mode with previous set value.

MP5S/MP5Y/MP5W/MP5M Series

●Parameter group 2

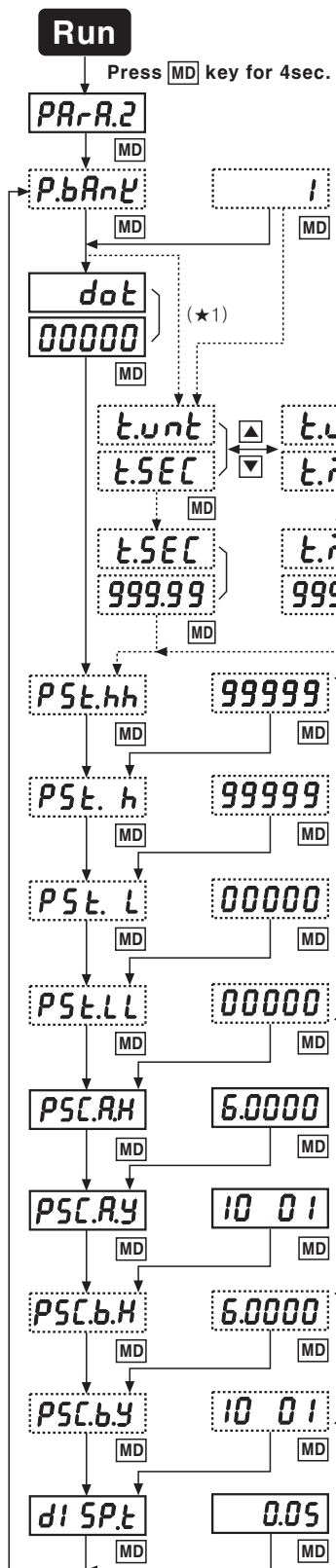

This is Parameter group 2.

Display **PAR.A.2** for 2 sec. and move to [**dot**] parameter automatically.

※MP5W series display **PAR.A.2** for 2sec. and move to [**P.bAnL**] parameter automatically.

Select Data Bank.

→ 1 → 2 (▼, ▲: Change the setting value)

Only MP5W type has the data bank parameter.

Set the decimal point position of display value.

→ 00000 (◀, ▶: Change the setting value)

It will be displayed in F3, F4, F5, F6 operation mode and set the **time unit**.

→ t.SEC → t.min (▼, ▲: Change the setting value)

It will be displayed in F3, F4, F5, F6 operation mode and set the **time range**.

→ 999.99 → 9999.9 → 99599 (▼, ▲: Change the setting value)
 959.59(sec.)
 99999 ← 999.59(min.)

Set the comparative value HH. See "Setting range of comparative value by operating mode" for setting range. (◀:Shift the setting digit ▼, ▲:Change the setting value)

Set the comparative value H. See "Setting range of comparative value by operating mode" for setting range. (◀:Shift the setting digit ▼, ▲:Change the setting value)

(★2) Set the comparative value L. See "setting range of comparative value by operating mode" for setting range. (◀:Shift the setting digit ▼, ▲:Change the setting value)

Set the comparative value LL. See "Setting range of comparative value by operating mode" for setting range. (◀:Shift the setting digit ▼, ▲:Change the setting value)

Set the prescale value of input A mantissa(X).
 Setting range : 0000 1 to 99999
 (◀:Shift the setting digit ▼, ▲:Change the setting value)

Set the prescale value of input A an exponent(y).
 Setting range : 10 - 9 to 10 09 (10⁻⁹ to 10⁹)
 (◀:Shift the setting digit ▼, ▲:Change the setting value)

(★3) Set the prescale value of input B mantissa(X).
 Setting range : 0000 1 to 99999
 (◀:Change the digit ▼, ▲:Change the setting value)

Set the prescale value of input A an exponent(y).
 Setting range : 10 - 9 to 10 09 (10⁻⁹ to 10⁹)
 (◀:Change the digit ▼, ▲:Change the setting value)

Select the display cycle.
 → 0.05 → 0.5 → 1 → 2 → 4 → 8 (Unit:sec.)
 (▼, ▲:Change the setting value)

●Time range by time unit

SEC	MIN
999.99sec.	999.99min.
9999.9 sec.	9999.9min.
99min59.9sec.	99hour59.9min.
9hour59min59sec.	999hour59min.
99999sec.	99999min.

●Setting range of comparative value by operation mode

Series	Operation mode	Setting range
MP5S MP5Y MP5W	F1, F2, F7, F9, F11, F12, F13	0 to 99999
	F3, F4, F5, F6	0 to Setting time range
	F8, F10	-19999 to 99999
MP5M	F1, F2, F7, F8, F9, F10, F11	0 to 99999
	F3, F4, F5, F6	0 to Setting time range

※The setting range is changed by setting position of decimal point.

※If MD key is pressed for 4sec.in **RUN** mode, [**PAR.A.2**] will be displayed after [**PAR.A.1**]. If MD key is released, it is advance to Parameter group 2.

※When advance to Parameter group 2, parameter and set data value is flashed as 1sec cycle.

※(★1)It will be displayed only in F3, F4, F5, F6 modes.

※(★2)If F mode is selected among output modes, it is set H and L deviation only, therefore [**PSt.hh**] and [**PSt.LL**] parameter will not appear.

※(★3)It will be displayed only in F7, F8, F9, F10 modes. But in case of MP5M type, it is displayed only in F7, F8 modes.

※After setting value in each parameter is changed, data will be saved by press MD key for 2sec. and return to **RUN** mode, but if any key is untouched for 60sec. while changing data, it will return to **RUN** move with previous set value.

Pulse(Rate) Meter

●Parameter group 3

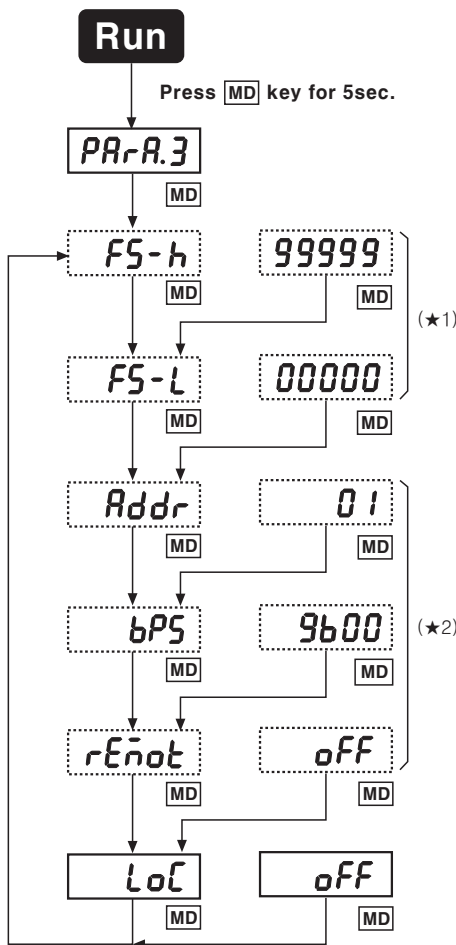

This is Parameter group 3.
Display **PAR.A.3** for 2 sec. and move to [**FS-h**] parameter automatically.

Set the High-limit value of PV transmission output.
See "Setting range of comparative value by operating mode"
for setting range
(**◀**:Shift the setting digit **▼**, **▲**:Change the setting value)

Set the Low-limit value of PV transmission output.
(**◀**:Shift the setting digit **▼**, **▲**:Change the setting value)

Set the communication Address.
setting range : **01** to **99**
(**◀**:Shift the setting digit **▼**, **▲**:Change the setting value)

Set the communication Speed.
→ **9600** → **4800** → **2400** →
(**◀**:Shift the setting digit **▼**, **▲**:Change the setting value)

Select the Remote and the Local.
→ **off** → **on** (**off** : Local, **on** : Remote)
(**▼**, **▲**:Change the setting value)

Enable to lock the key for each parameter group
→ **off** → **LoC.0** → **LoC.1** → **LoC.2** → **LoC.3** →
(**▼**, **▲**:Change the setting value)

●Setting range of comparative value by operation mode

Series	Operation mode	Setting range
MP5S MP5Y MP5W	F1, F2, F7, F9, F11, F12, F13	0 to 99999
	F3, F4, F5, F6	0 to Setting time range
MP5M	F1, F2, F7, F8, F9, F10, F11	0 to 99999
	F3, F4, F5, F6	0 to Setting time range

*The setting range is changed by setting position of decimal point.

※If **MD** key is pressed for 5sec. in **RUN** mode, [**PAR.A.3**] will be displayed after [**PAR.A.1**] and [**PAR.A.2**].
If **MD** key is released, it is advance to Parameter group 3.

※When it advances into Parameter group 3, parameter and data value is flashed as 1sec. cycle.

※(★1)The parameter is displayed in case of PV transmission output type only.

※(★2)The parameter is displayed in case of RS485 transmission output type only. When Remote [**rEnot**] is selected, it is not able to operate front keys.

※After setting value in each parameter is changed, data will be saved by press **MD** key for 2sec and return to **RUN** mode, but if any key is untouched for 60sec while changing data, it will return to **RUN** move with previous set value.

■Factory defaults

●Parameter 1 group

Mode	Setting value
nodE	F1
in-A	nPnhF
out-t	StAr d
hYS	0001
GuAr.d	F.dEFY
AuLoA	99999
nEno	off

●Parameter 2 group

Mode	Setting value
PbAr t	1
dot	00000
PSt.hh	99999
PSt. h	99999
PSt. L	00000
PSt.LL	00000
PSCAH	6.000
PSCAY	10 01
dI SP.t	005

●Parameter 3 group

Mode	Setting value
FS-h	99999
FS-L	00000
Addr	01
bPS	9600
rEnot	off
LoC	off

※Setting specification may not be displayed because of operation mode or output specification.

(A)	Photo electric sensor
(B)	Fiber optic sensor
(C)	Door/Area sensor
(D)	Proximity sensor
(E)	Pressure sensor
(F)	Rotary encoder
(G)	Connector/Socket
(H)	Temp. controller
(I)	SSR/Power controller
(J)	Counter
(K)	Timer
(L)	Panel meter
(M)	Tacho/Speed/Pulse meter
(N)	Display unit
(O)	Sensor controller
(P)	Switching power supply
(Q)	Stepping motor & Driver & Controller
(R)	Graphic/Logic panel
(S)	Field network device
(T)	Production stoppage models & replacement

MP5S/MP5Y/MP5W/MP5M Series

Operation mode

- Select operation mode from $\tilde{n}odE$ (mode) of Parameter group 1.
- There are 13 kinds of operation mode in MP5S, MP5Y, MP5W.
There are 11 kinds of operation mode in MP5M series.

Mode F1 (Frequency/Number of revolution/Speed)

This mode is to display calculated frequency or number of revolution or speed by measuring frequency of Input A.

1) **Frequency(Hz) = $f \times \alpha$** [$\alpha = 1(\text{sec.})$]

2) **Number of revolution(rpm) = $f \times \alpha$** [$\alpha = 60(\text{sec.})$]

Several targets $\alpha = 60 \times \frac{1}{N}$

3) **Speed(m/min) = $f \times \alpha$** [$\alpha = 60 \times L(\text{m})$]

Several targets $\alpha = 60 \times L \times \frac{1}{N}$

※ L = The length of conveyor moved for 1 pulse cycle [m]

N : Number of sensing target
(Number of pulse per revolution)

α : Prescale value

Display value and display unit

Display value	Display unit	α (Prescale value)
Frequency	Hz	1
	kHz	0.001
Number of revolution	RPS	1
	rpm	60
Speed	mm / sec.	1,000L
	cm / sec.	100L
	m / sec.	L
	m / min.	60L
	km / hour	3.6L

※ Display unit of default : rpm

Time chart

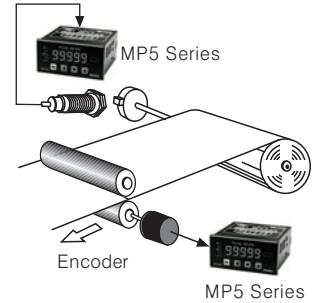
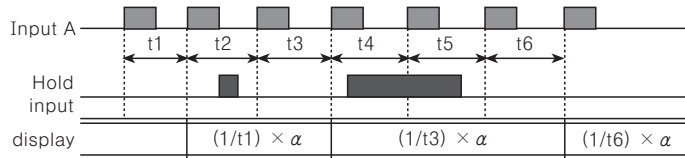

Mode F2 (Passing speed)

Display the passing speed between ON of input A and ON of input B.

Passing speed(V) = $f \times \alpha$ [$\alpha = L(\text{m})$]

※ f : This is reciprocal number of the time between ON of input A and ON of input B.

L : The distance between input A and input B [m]

α : Prescale value

Display value and display unit

Display value	Display unit	α (Prescale value)
Passing speed	mm / sec.	1,000L
	cm / sec.	100L
	m / sec.	L
	m / min.	60L
	km / hour	3.6L

※ Display unit of factory default : m/sec.

Time chart

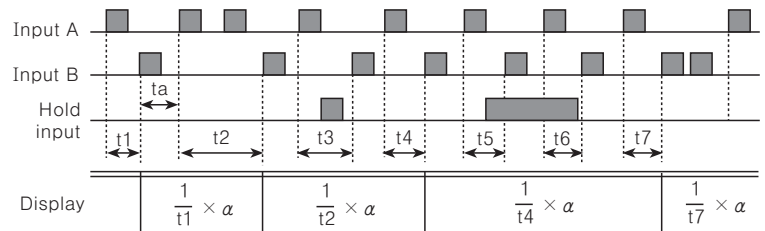

ta : It requires min. 20ms for return time

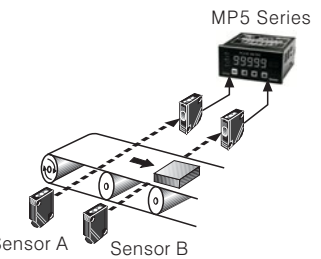

Mode F3 (Cycle)

Display the time from when input A is ON to the next ON.

Cycle(T) = t

※ t : Measurement time [sec.]

Display value and display unit

Cycle	Display unit	
	SEC	MIN
	999.99sec.	999.99min.
	9999.9sec.	9999.9min.
	99min. 59.9sec.	99hour 59.9min.
	9hour 59min. 59sec.	999hour 59min.
99999sec.	99999min.	

※ Set the display unit at the t_{unit} (Time unit) of Parameter 2.

※ Display unit of factory default : 999.99sec.

Time chart

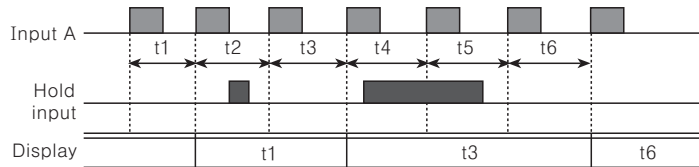

※ t1 to t6 should be over min. 20ms for measuring.

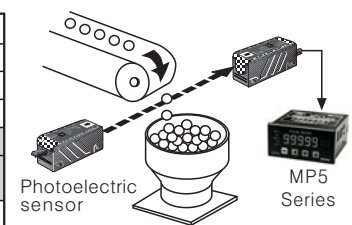

※ [] is not displayed in MP5M-4N, MP5M-41, MP5M-42.

Pulse(Rate) Meter

●Mode F4(Passing time)

It displays the pass time of certain distance to measure the time between ON and the next ON of Input A.

$$\text{Passing time(sec)} = t \times \alpha$$

$$\left[\alpha = \frac{L(m)}{\text{Moving distance within 1pulse cycle[m]}} \right]$$

- ※ t : Measurement time[sec.]
- L : Certain distance[m]
- ※ α : Presale value

※  is not displayed in MP5M-4N, MP5M-41, MP5M-42.

●Display value and display unit

Display value	Display unit	
	SEC	MIN
Passing time	999.99sec.	999.99min.
	9999.9sec.	9999.9min.
	99min. 59.9sec.	99hour 59.9min.
	9hour 59min. 59sec.	999hour 59min.
	99999sec.	99999min.

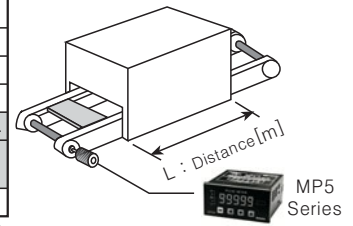

- ※ Set the display unit at the **t.un**t (Time unit) of Parameter 2.
- ※ Display unit of factory default : 999.99sec.

●Time chart

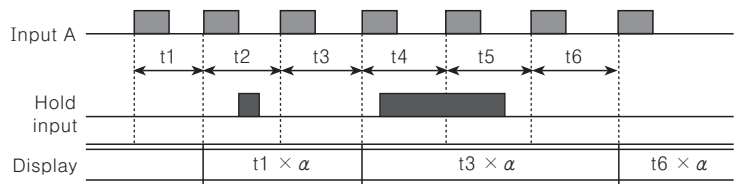

- (A) Photo electric sensor
- (B) Fiber optic sensor
- (C) Door/Area sensor
- (D) Proximity sensor
- (E) Pressure sensor
- (F) Rotary encoder
- (G) Connector/Socket
- (H) Temp. controller
- (I) SSR/Power controller
- (J) Counter
- (K) Timer
- (L) Panel meter
- (M) Tacho/Speed/Pulse meter
- (N) Display unit
- (O) Sensor controller
- (P) Switching power supply
- (Q) Stepping motor & Driver & Controller
- (R) Graphic/Logic panel
- (S) Field network device
- (T) Production stoppage models & replacement

●Mode F5(Time width)

It displays the ON time of input A.

$$\text{Time width(T)} = t$$

- ※ t : ON measurement time of input A [sec.]

※  is not displayed in MP5M-4N, MP5M-41, MP5M-42.

●Display value and display unit

Display value	Display unit	
	SEC	MIN
Time width	999.99sec.	999.99min.
	9999.9sec.	9999.9min.
	99min. 59.9sec.	99hour 59.9min.
	9hour 59min. 59sec.	999hour 59min.
	99999sec.	99999min.

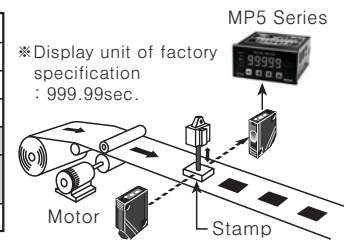

- ※ Display unit of factory specification : 999.99sec.

- ※ Set the display unit at the **t.un**t (Time unit) of Parameter 2.
- ※ Display unit of factory default : 999.99sec.

●Time chart

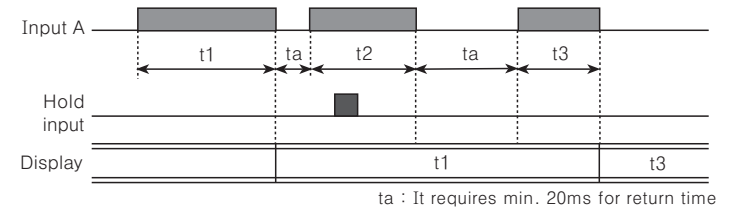

ta : It requires min. 20ms for return time

●Mode F6(Time difference)

It displays the time from input A is ON to input B is ON.

$$\text{Time difference(T)} = t(Ta \sim Tb)$$

- ※ t(Ta ~ Tb) : The measured time from input A is ON to input B is ON[sec.]

※  is not displayed in MP5M-4N, MP5M-41, MP5M-42.

●Display value and display unit

Display value	Display unit	
	SEC	MIN
Time interval	999.99sec.	999.99min.
	9999.9sec.	9999.9min.
	99min. 59.9sec.	99hour 59.9min.
	9hour 59min. 59sec.	999hour 59min.
	99999sec.	99999min.

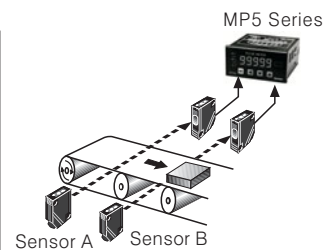

- ※ Set the display unit at the **t.un**t (Time unit) of Parameter 2.
- ※ Display unit of factory default : 999.99sec.

●Time chart

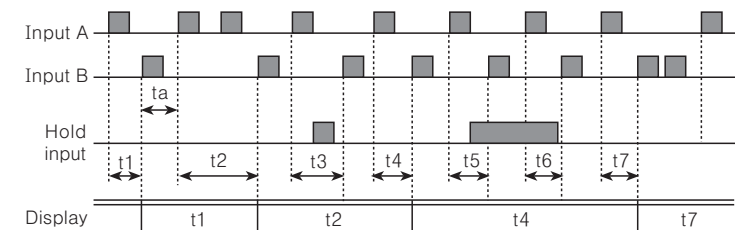

ta : It requires min. 20ms for return time

MP5S/MP5Y/MP5W/MP5M Series

●Mode F7(Absolute ratio)

It displays how fast or late Input B comparing to Input A as well as speed or amount of Input, as a percentage.

$$\text{Absolute ratio} = (\text{Input B} / \text{Input A}) \times 100\%$$

$$\text{Absolute ratio} = \frac{\text{Frequency of input B[Hz]} \times B\alpha}{\text{Frequency of input A[Hz]} \times A\alpha} \times 100[\%]$$

※A α: Prescale for input A

B α: Prescale for input B

●Display value and display unit

Display value	Display unit
Absolute ratio	%

●Time chart

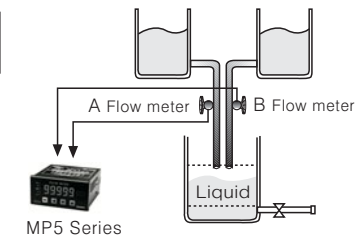
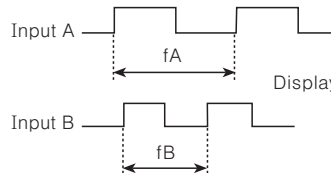

※Hold: Hold signal is ON, the display value will be held until Hold signal is OFF.

●Mode F8(Error ratio)

It displays how fast or late as a percentage (%) for input B against input A.

$$\text{Error ratio} = \frac{\text{Input B} - \text{Input A}}{\text{Input A}} \times 100[\%]$$

$$\text{Error ratio} = \frac{(\text{Frequency of input B[Hz]} \times B\alpha) - (\text{Frequency of input A[Hz]} \times A\alpha)}{\text{Frequency of input A[Hz]} \times A\alpha} \times 100[\%]$$

※Error ratio mode is not available in MP5M-4N, MP5M-41, MP5M-42 models.

●Display value and display unit

Display value	Display unit
Error ratio	%

※A α: Prescale for input A

B α: Prescale for input B

●Time chart

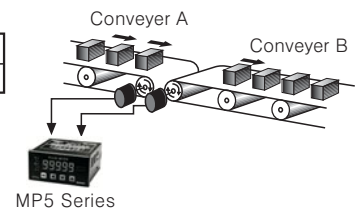
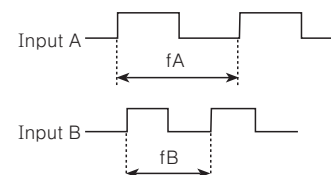

※Hold: Hold signal is ON, the display value will be held until Hold signal is OFF.

●Mode F9(Density)

It displays the density ratio of input B against total sum of input A and input B.

$$\text{Density} = \frac{\text{Input B}}{\text{Input A} + \text{Input B}} \times 100[\%]$$

$$\text{Density} = \frac{\text{Frequency of input B[Hz]} \times B\alpha}{(\text{Frequency of input A[Hz]} \times A\alpha) + (\text{Frequency of input B[Hz]} \times B\alpha)} \times 100[\%]$$

●Display value and display unit

Display value	Display unit
Density	%

※A α: Prescale value of input A

B α: Prescale value of input B

●Time chart

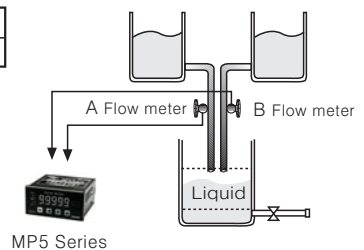
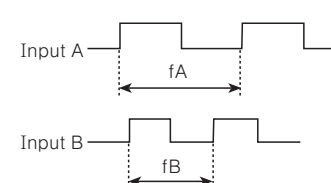

※Hold: Hold signal is ON, the display value will be held until Hold signal is OFF.

※F8 mode is applied to MP5M-4N, MP5M-41, MP5M-42 models.

Pulse(Rate) Meter

●Mode F10(Error)

It displays the error between standard input A and comparing input B.

$$\text{Error} = \text{Input B} - \text{Input A}$$

$$\text{Error} = (\text{Frequency of input B[Hz]} \times B\alpha) - (\text{Frequency of input A[Hz]} \times A\alpha)$$

※There is no error mode in MP5M-4N, MP5M-41, MP5M-42 models.

●Display value and display unit

Display value	Display unit
Error	END User setting unit

※A α : Prescale value of input A
B α : Prescale value of input B

●Time chart



※Hold : Hold signal is ON, the display value will be held until Hold signal is OFF.

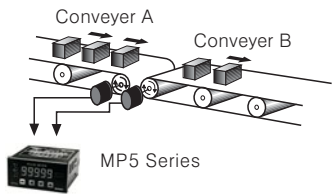

●Mode F11(Length measurement)

It displays the number of input A pulse while input B is ON.

$$\text{Length measurement} = P \times \alpha$$

※P : Number of input A pulse,
α : Prescale value

●Display value and display unit

Display value	Display unit
	Quantity[EA]
	mm
	cm
m	

※Factory default (Unit) : Quantity [EA]

●Time chart

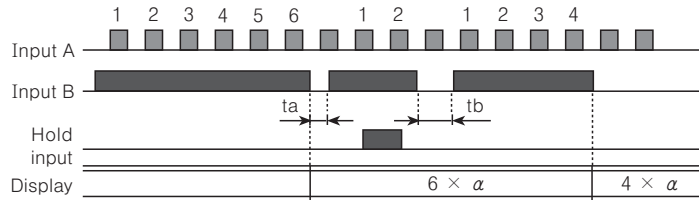

※ta, tb : It requires min. 20ms for return time

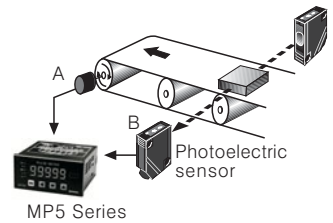

※F9 mode is applied to MP5M-4N, MP5M-41, MP5M-42 models.

●Mode F12(Interval)

It displays the number of input A pulse from input B is ON to the time input B is ON next.

$$\text{Interval} = P \times \alpha$$

※P : Number of input A pulse,
α : Prescale value

●Display value and display unit

Display value	Display unit
	Quantity[EA]
	mm
	cm
m	

※Factory default (Unit) : Quantity [EA]

●Time chart

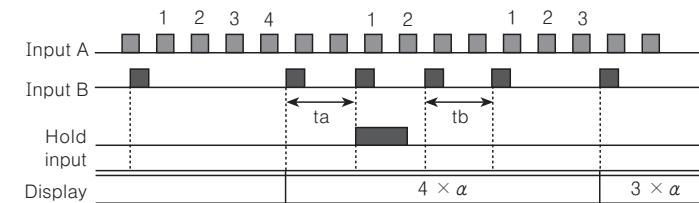

※ta : It requires min. 20ms for return time

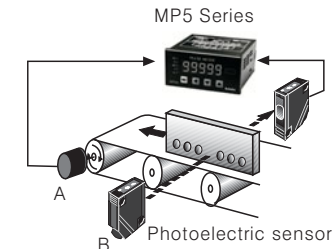

※F10 mode is applied to MP5M-4N, MP5M-41, MP5M-42 models.

●Mode F13(Multiplication)

It displays the counting value against pulses of input A.

$$\text{Multiplication} = P \times \alpha$$

※P : Pulse number of input A,
α : Prescale value

※Max. counting speed : 50kcps
(same with max. response frequency)

※F11 mode is applied to MP5M-4N, MP5M-41, MP5M-42 models.

●Display value and display unit

Display value	Display unit
Multiplication	Quantity[EA]

●Operation and Time chart

①It counts the number of Input A pulse.

②Input B is an Enable/Disable input signal, when Input B is ON, meter stops the counting and display value of Input A, when Input B is OFF, meter counts Input A again.

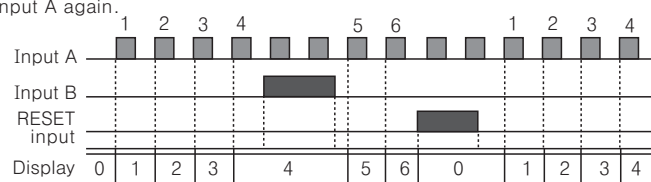

※α=1 display value

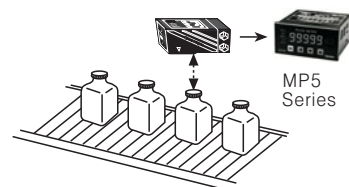

(A)	Photo electric sensor
(B)	Fiber optic sensor
(C)	Door/Area sensor
(D)	Proximity sensor
(E)	Pressure sensor
(F)	Rotary encoder
(G)	Connector/Socket
(H)	Temp. controller
(I)	SSR/Power controller
(J)	Counter
(K)	Timer
(L)	Panel meter
(M)	Tacho/Speed/Pulse meter
(N)	Display unit
(O)	Sensor controller
(P)	Switching power supply
(Q)	Stepping motor & Driver & Controller
(R)	Graphic/Logic panel
(S)	Field network device
(T)	Production stoppage models & replacement

MP5S/MP5Y/MP5W/MP5M Series

Output mode

- Select output mode in **out-t** (output type) of Parameter group 1.
- MP5 series are 6 kinds of output mode. There is no output mode in indicator type, MP5Y-43/44/45, MP5M-41 models.
 - ☞ S (Standard) output mode, H (High) output mode, L (Low) output mode, B (Block) output mode, I (One shot) output mode, F (Deviation) output mode.
- In order to set comparative value, B output mode should be LL < L < H < HH, other S, H, L, I output modes operate individually, regardless of value size of comparative setting value. (There is no GO, HH, LL, OUTPUT in MP5M-42)

Standard output mode [out-s]

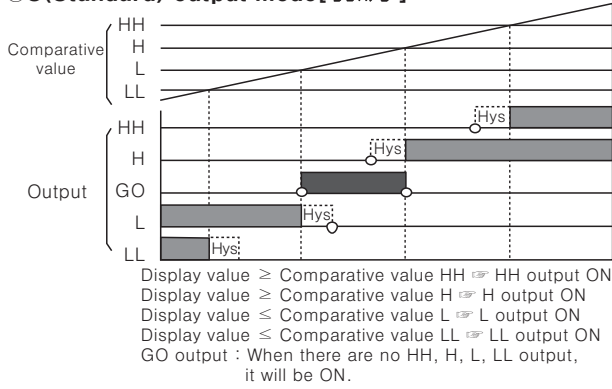

One Shot output mode [out-i]

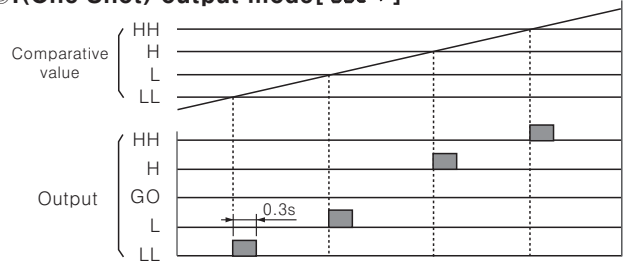

High output mode [out-h]

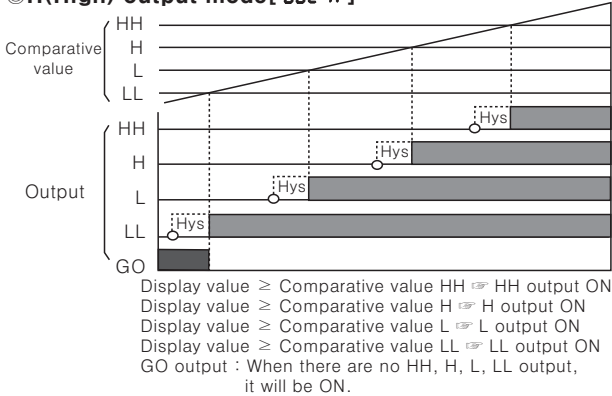

Deflection output mode [out-f]

This function is to memorize the setting value and it outputs when exceed the deviation of H, L.

- Memorize the setting value : Memorize the current display value as the setting value with pressing (M + ▲) key is front.
- Display the setting value : Check the memorized the setting value by (▲) key. (Display the memorized setting value for pressing ▲ key continuously.)
- Deviation setting : Set H [P5t.h], L [P5t.L] deviation by setting value. (The set deviation will be memorized until set the next deviation again when power off.)
- Deviation setting range : 0.0001 to 99999 (The setting range will be changed by decimal point setting parameter. If setting decimal point as 0000.0, the setting range will be 0.1 to 9999.9.)
- Operation : Display value \leq L Comparative value \Rightarrow L Comparative output ON,
 Display value \geq H Comparative value \Rightarrow H Comparative output ON

Low output mode [out-l]

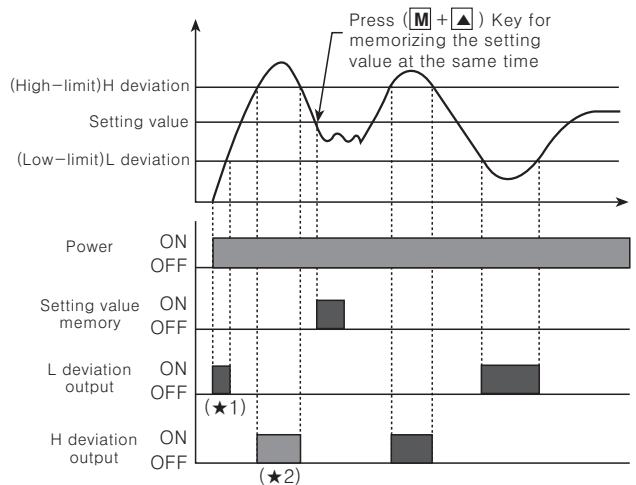
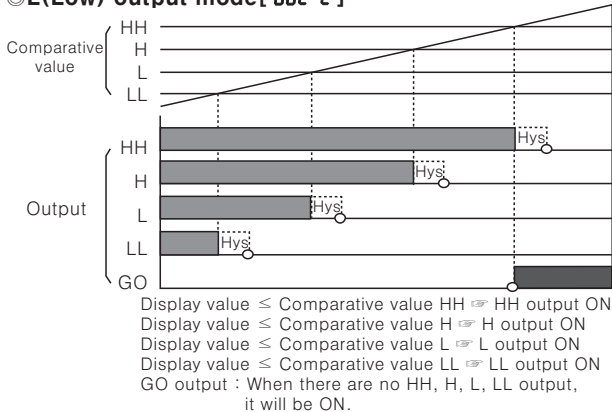

Block output mode [out-b]

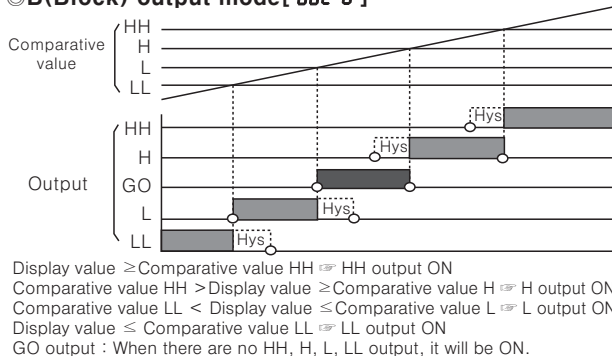

- * (★1) When selecting the comparative output limit function, Initial output will not be come.
- * (★2) The output on the above is on the assumption that the prior setting value of memory can be available.
- * There are no HH, GO, LL outputs in F output mode.
- * Even though, set the deviation as "0 (Zero)", it will work as "deviation 1".

Pulse(Rate) Meter

Function

Selection of display interval

It measures and displays reciprocal number of measuring time to detect target. Measuring accuracy may be dropped because the measuring time of interval is short, if the target is revolving with high speed.

It is able to change the display cycle in range of 0.05/0.5/1/2/4/8sec.) and displays the average value of measuring value then able to maintain measuring accuracy when revolving with high speed. In case of preset output type, the response can be delayed when the measuring time is long. Therefore, please adjust the measuring time properly.

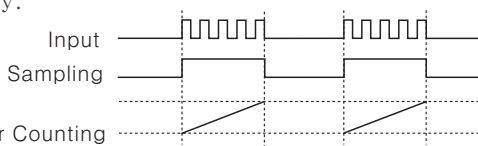

※Select display sampling period in parameter 2.

Prescale function

This prescale function allows to multiply the number of pulse or pulse length by a variable ($X \times 10^y$) then display specification of measurement.

It will display frequency or RPM from prescale value by measuring the input frequency. For example, what is prescale value α when rpm is displayed?

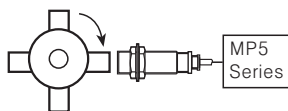

$$\begin{aligned} \text{RPM} &= f \times \alpha \\ &= f \times 60 \times (1 / N) \\ &= f \times 60 \times (1 / 4) \\ &= f \times 60 \times 0.25 \\ &= f \times 15 \end{aligned}$$

- ※ f : Input pulse (Frequency) per sec.
- ※ α : Prescale value
- ※ N : Pulse number per 1 revolution

Prescale value ($\alpha=15$) setting

Set Prescale value (α) as (X) and (y) separately in **PSC.A.H**, **PSC.A.Y** (**PSC.b.H**, **PSC.b.Y**) of Parameter group 2. Set Prescale ($\alpha=15$) as (X):1.5000, (y):10¹

It is also able to get the same display value even though set as X=0.1500, y=10²
 X setting range : 0.0001 to 9.9999
 Y setting range : 10⁻⁹ to 10⁹

Peak value monitoring function

It saves High Peak value **h.PEV** or Low Peak value **L.PEV** against display value.

- It can check in parameter group 0, the High Peak (**h.PEV**) value or the Low Peak (**L.PEV**) value will be continuously saved during checking.
- Refer to Parameter group 0 for Reset.

Monitoring delay function

It controls stably to limit L, LL output until certain output is displayed or all output until the equipment will be in a stable status against various change of input such as the starting current when the motor is running after power on.

Starting correction timer function

(**StArr.t** mode of Parameter group 1)

This function is to inhibit the output come for the setting time. (Time setting range 0.0 to 99.9sec.)
 Applicable output mode : S, H, L, B, I, F mode

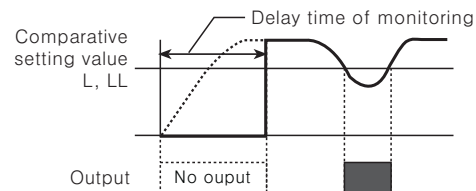

Comparative output limit function

(**F.dEFY** mode of Parameter1 group)

This function is to limit the LL, L output before H or HH output.

Applicable output mode : S, B, F mode

The output mode is S output mode (Initial operation after supplying power)

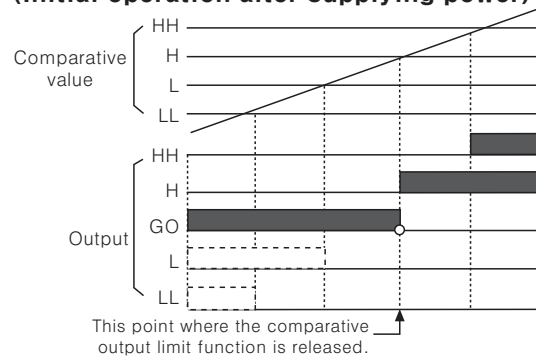

- ※ Initial L, LL comparative output does not operate after supplying power.
- ※ Each setting value of HH, H, L, LL is not effected by each other. Therefore, HH value may be equal or lower than LL value.

The output mode is B output mode (Initial operation after supplying power)

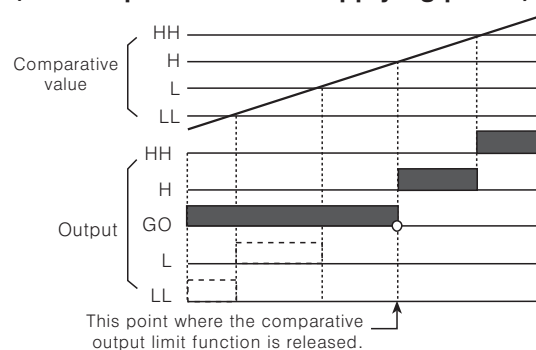

- ※ Initial L, LL comparative output does not operate after supplying power.
- ※ Each setting value of HH, H, L, LL effects on each other. Therefore, setting value should be LL<L<H<HH in sequence.

(A)	Photo electric sensor
(B)	Fiber optic sensor
(C)	Door/Area sensor
(D)	Proximity sensor
(E)	Pressure sensor
(F)	Rotary encoder
(G)	Connector/Socket
(H)	Temp. controller
(I)	SSR/Power controller
(J)	Counter
(K)	Timer
(L)	Panel meter
(M)	Tacho/Speed/Pulse meter
(N)	Display unit
(O)	Sensor controller
(P)	Switching power supply
(Q)	Stepping motor & Driver & Controller
(R)	Graphic/Logic panel
(S)	Field network device
(T)	Production stoppage models & replacement

MP5S/MP5Y/MP5W/MP5M Series

●The output mode is F output mode (Initial operation after supplying power)

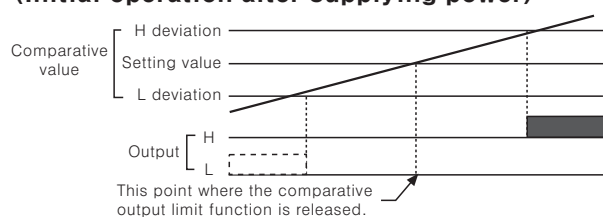

- ※Initial L comparative output does not operate after supplying power.
- ※The comparative output limit function will be released at the setting value(Standard setting).

◎Hysteresis function

Set the Hysteresis value(A) for comparative setting value in order to prevent unstable operation due to output is ON/OFF frequently.

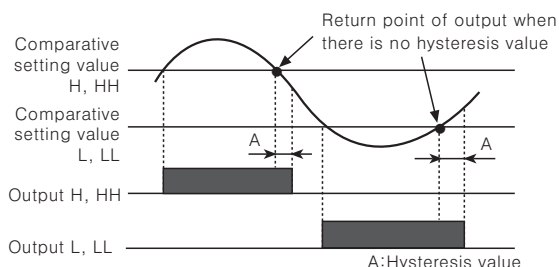

DOT position	Setting range
00000	0000 to 9999
0000.0	000.0 to 999.9
000.00	00.00 to 99.99
00.000	0.000 to 9.999
0.0000	0.000 to 0.999

- ※It is able to set "0" but when set "0", the actual operation will be as "1".
- ※The initial setting value is 0001.
- ※It is able to set in "**h95**" mode of Parameter group 1.

◎Auto-Zero time setting function

If there is no pulse input within setting time(Auto-zero time), it regards as the input signal is cut off then make the value as "00000" forcibly. Note that the Auto-zero time setting should be longer than the widest interval of input pulse. Otherwise it may be difficult to make the display value as "00000".

- Auto-zero time setting range : 0.1 to 9999.9sec. (Factory default setting : 9999.9sec.)
- When the display value is "00000", each output will respond to how it was programmed for "0".
- Set the time in "**Auto.a**" and "**Auto.b**" mode of parameter group 1.

Be sure that some operation modes are not displayed. Please refer to M-13.

◎Lock setting function

This function is to set the enable or disable of each Parameter and mode changes.

Parameter	Parameter 0 group	Parameter 1 group	Parameter 2 group	Parameter 3 group
OFF	—	—	—	—
LoC 0	●	●	●	●
LoC 1	—	●	●	●
LoC 2	—	—	●	●
LoC 3	—	—	—	●

- ※ -: Unlock, ● : Lock
- ※Lock setting is available in Parameter 3 group.

◎Inner hardware Lock setting function

This function is to lock **LoC** in Parameter 3 group by Inner hardware Lock function in order to prevent wrong setting.

●MP5S, MP5Y, MP5W Series

	Pin	LoC mode	Remark
h0(Hardware Lock0)		Check:○, Change:○	Factory default
h1(Hardware Lock1)		Check:○, Change:×	
h2(Hardware Lock2)		Check:×, Change:×	

- ※Setting pin for Lock setting is located on internal PCB.

●MP5M Series

	SW	LoC mode
h0 (Hardware Lock0)	ON	Check:○, Change:○
	OFF	
h1 (Hardware Lock1)	ON	Check:○, Change:×
	OFF	
h2 (Hardware Lock2)	ON	Check:×, Change:×
	OFF	

- ※It is possible to lock or unlock after supplied power in Inner hardware Lock setting.

◎Data bank switching function

This is a function to save comparative setting value and prescale value in each data bank(Data Bank 1, Data Bank 2) in order to make easy to use necessary data saved in each data bank.

- When terminal No.3 and 5 are open, comparative value and prescale value in Data Bank 1 will be activated.
- When terminal No.3 and 5 are shorted, comparative value and prescale value in Data Bank 2 will be activated.
- How to save comparative value and prescale value in each Data Bank : Enter into parameter 2 group **P.bAnE** and select the Data Bank where you save the data. Then, save each comparative setting value and prescale value.

- ※Data bank switching function is in MP5W series only.

Pulse(Rate) Meter

◎Time unit selection function

Enable to display PV value in various time ranges.

- Time unit selection function can be set in parameter 2 group.
- Applicable mode : Mode F3 to F6

SEC	MIN
999.99sec.	999.99min.
9999.9sec.	9999.9min.
99min59.9sec.	99hour59.9min.
9hour59min59sec.	999hour59min.
99999sec.	99999min.

- ※There is no "dot" setting mode when select F3 to F6 operation mode.
- ※Time range of(■) part is not displayed in MP5M series.

◎Case detachment(DIP switch)

Please detach the case after turning off the power.

- MP5W Series/MP5Y Series/MP5S-□N

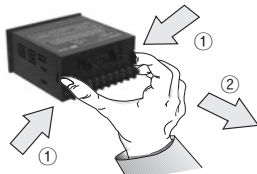

※Please press a pull of terminal ① and pull it toward ② direction.

- MP5M Series

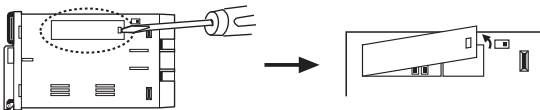

Pushing the Lock of DIP switch cover with a driver, squeeze and pull toward the outside, it detached.

※Please be careful of the injury caused by tools.

■Communication output

◎System structure

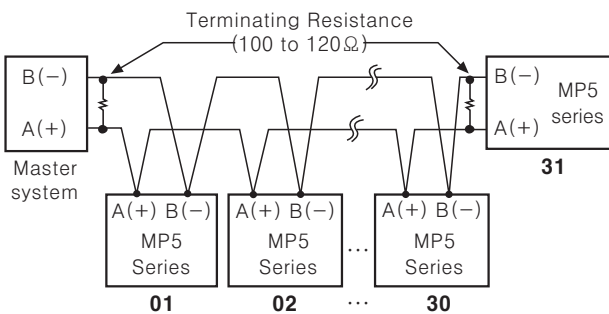

◎Communication control ordering

1. The communication control ordering of MP5 series is private protocol(Not compatible with other system).
2. After 4sec. being supplied the power into master system, then it starts to communicate.
3. Initial communication will be started by master system. When Command signal comes out from master system then MP5 series will response. If there is no response after 3times of the command signal from master system, error will be occurred.

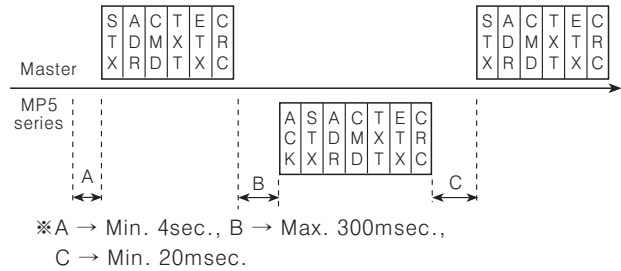

◎Communication command and block

Format of command and response

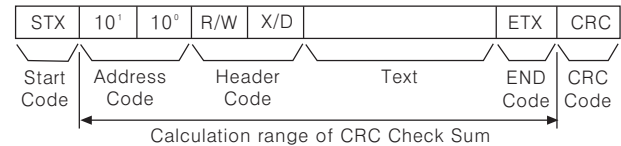

①Start code

It shows the first of BLOCK

STX → [02H], in case of Response, ACK/NAK will be added.

②Address code

This code is master system can discern MP5 series and able to set within range of 01 to 99. (BCD ASCII)

③Header code

It shows Command as 2 alphabets as below.

RX(Read request) → R[52H], X[58H]

RD(Read response) → R[52H], D[44H]

WX(Write request) → W[57H], X[58H]

WD(Write response) → W[57H], D[44H]

④Text

It indicates the detail contents of Command /Response. (Refer to command item)

⑤END code

It indicates the end of BLOCK. ETX → [03H]

⑥CRC

CRC is cyclic redundancy check and called polynomial code. CRC is for more reliable transmit/receive to check the error between transmitter and receiver.

There are CRC-8, CRC-16 and CRC-32, CRC-8 has been adopted in MP5 series according to CCITT-8 Polynomial regulation.

(Refer to CRC8 table) Result value is HEX 1 Byte.

< CRC8 Table >

	0	1	2	3	4	5	6	7	8	9	A	B	C	D	E	F
0	0x00	0x5E	0xBC	0xE2	0x61	0x3F	0xDD	0x83	0xC2	0x9C	0x7E	0x20	0xA3	0xFD	0x1F	0x41
1	0x9D	0xC3	0x21	0x7F	0xFC	0xA2	0x40	0x1E	0x5F	0x01	0xE3	0xBD	0x3E	0x60	0x82	0xDC
2	0x23	0x7D	0x9F	0xC1	0x42	0x1C	0xFE	0xA0	0xE1	0xBF	0x5D	0x03	0x80	0xDE	0x3C	0x62
3	0xBE	0xE0	0x02	0x5C	0xDF	0x81	0x63	0x3D	0x7C	0x22	0xC0	0x9E	0x1D	0x43	0xA1	0xFF
4	0x46	0x18	0xFA	0xA4	0x27	0x79	0x9B	0xC5	0x84	0xDA	0x38	0x66	0xE5	0xBB	0x59	0x07
5	0xDB	0x85	0x67	0x39	0xBA	0xE4	0x06	0x58	0x19	0x47	0xA5	0xFB	0x78	0x26	0xC4	0x9A
6	0x65	0x3B	0xD9	0x87	0x04	0x5A	0xB8	0xE6	0xA7	0xF9	0x1B	0x45	0xC6	0x98	0x7A	0x24
7	0xF8	0xA6	0x44	0x1A	0x99	0xC7	0x25	0x7B	0x3A	0x64	0x86	0xD8	0x5B	0x05	0xE7	0xB9
8	0x8C	0xD2	0x30	0x6E	0xED	0xB3	0x51	0x0F	0x4E	0x10	0xF2	0xAC	0x2F	0x71	0x93	0xCD
9	0x11	0x4F	0xAD	0xF3	0x70	0x2E	0xCC	0x92	0xD3	0x8D	0x6F	0x31	0xB2	0xEC	0x0E	0x50
A	0xAF	0xF1	0x13	0x4D	0xCE	0x90	0x72	0x2C	0x6D	0x33	0xD1	0x8F	0x0C	0x52	0xB0	0xEE
B	0x32	0x6C	0x8E	0xD0	0x53	0x0D	0xEF	0xB1	0xF0	0xAE	0x4C	0x12	0x91	0xCF	0x2D	0x73
C	0xCA	0x94	0x76	0x28	0xAB	0xF5	0x17	0x49	0x08	0x56	0xB4	0xEA	0x69	0x37	0xD5	0x8B
D	0x57	0x09	0xEB	0xB5	0x36	0x68	0x8A	0xD4	0x95	0xCB	0x29	0x77	0xF4	0xAA	0x48	0x16
E	0xE9	0xB7	0x55	0x0B	0x88	0xD6	0x34	0x6A	0x2B	0x75	0x97	0xC9	0x4A	0x14	0xF6	0xA8
F	0x74	0x2A	0xC8	0x96	0x15	0x4B	0xA9	0xF7	0xB6	0xE8	0x0A	0x54	0xD7	0x89	0x6B	0x35

- (A) Photo electric sensor
- (B) Fiber optic sensor
- (C) Door/Area sensor
- (D) Proximity sensor
- (E) Pressure sensor
- (F) Rotary encoder
- (G) Connector/Socket
- (H) Temp. controller
- (I) SSR/Power controller
- (J) Counter
- (K) Timer
- (L) Panel meter
- (M) Tacho/Speed/Pulse meter
- (N) Display unit
- (O) Sensor controller
- (P) Switching power supply
- (Q) Stepping motor & Driver & Controller
- (R) Graphic/Logic panel
- (S) Field network device
- (T) Production stoppage models & replacement

MP5S/MP5Y/MP5W/MP5M Series

◎Communication command

●The Charictaristic(Number) at " " is ASCII.

Sort	ACK	STX	Addr	Command	Bank	Code	+/-	10 ⁵	10 ⁴	10 ³	10 ²	10 ¹	10 ⁰	DP	ETX	CRC
Read request	X	02		"R"	"X"			"0"	"0"	"0"	"0"	"0"	"0"	"0"	03	CRC
Read response		06	02		"R"	"D"									03	CRC
Write request	X	02		"W"	"X"										03	CRC
Write response		06	02		"W"	"D"									03	CRC

P 0	Process Value
C 0	Comparative Value HH
C 1	Comparative Value H
C 2	Comparative Value L
C 3	Comparative Value LL
K 0	Peak Value Max.
K 1	Peak Value Min.
X 0	Prescaling Value X.Ain
X 1	Prescaling Value X.Bin
Y 0	Prescaling Value Y.Ain
Y 1	Prescaling Value Y.Bin
R 0	Reset control of maximum/minimum values

●Read[RX] of measurement :

Address 01, Command RX

1. Command(Master)

- ①Command
- ②Application : Address(01), Header code (RX), Process value(P0) of Bank(0), CRC Check sum (B5H)

STX	0	1	R	X	0	P	0	+	0	0	0	0	0	0	0	ETX	CRC
Start	Address	Command	Bank	Command	Symbol	10 ⁵	10 ⁴	10 ³	10 ²	10 ¹	10 ⁰	Decimal point	END	Check sum			
02	30	31	52	58	30	50	30	2B	30	30	30	30	30	03	B5		

2. Response

①Normal receive : Adding ACK[06H] to current value of Data transmission Bank(0) is +1.234.

ACK	STX	0	1	R	D	0	P	0	+	0	0	1	2	3	4	3	ETX	CRC
ACK	Start	Address	Command	Bank	Command	Symbol	10 ⁵	10 ⁴	10 ³	10 ²	10 ¹	10 ⁰	Dec-imal point	End	Check sum			
06	02	30	31	52	44	30	50	30	2B	30	30	31	32	33	34	33	03	23

②Normal receive: Adding ACK[06H] to current value of Data transmission Bank(0) is -156.7.

ACK	STX	0	1	R	D	0	P	0	-	0	0	1	5	6	7	1	ETX	CRC
ACK	Start	Address	Command	Bank	Command	Symbol	10 ⁵	10 ⁴	10 ³	10 ²	10 ¹	10 ⁰	Dec-imal point	End	Check sum			
06	02	30	31	52	44	30	50	30	2D	30	30	31	35	36	37	31	03	75

●Write[WX] of measurement / setting value :

Address 01, Command WX

1. COMMAND(Master)

- ①Command
- ②Application : Address(01), Head Code(WX), The setting value into SV-HH (C0) of BANK(0) is +1.234.

STX	0	1	W	X	0	C	0	+	0	0	1	2	3	4	3	ETX	CRC
Start	Address	Command	Bank	Command	Symbol	10 ⁵	10 ⁴	10 ³	10 ²	10 ¹	10 ⁰	Dec-imal point	End	Check sum			
02	30	31	57	58	30	43	30	2B	30	30	31	32	33	34	33	03	5D

2. Response(MP5 Series)

When completing the operation after normal receive.

ACK	STX	0	1	W	D	0	C	0	+	0	0	1	2	3	4	3	ETX	CRC
ACK	Start	Address	Command	Bank	Command	Symbol	10 ⁵	10 ⁴	10 ³	10 ²	10 ¹	10 ⁰	Dec-imal point	End	Check sum			
06	02	30	31	57	44	30	43	30	2B	30	30	31	32	33	34	35	03	3C

3. CRC error : Transmit NAK [15H] only.

(Need to transmit again)

4. Other : No response of ACK/NAK

- ①After receiving STX, the address are not the same.
 - ②When receive buffer is overflown.
 - ③When the baud rate or other communication setting value are not the same.
5. If there is no response of ACK/NAK
- ①Check the status of lines
 - ②Check the communication condition (Setting value)
 - ③When the problem is occurred due to noise, try to operate communication 3 times more until recovery
 - ④When communication is failed frequently, please adjust the communication speed.

■Precaution for communicating with MP5 series

1. It is not possible to modify Parameter(Baud rate, Address etc)related to communication of MP5 series on line with high order systems such as PC, PLC etc. (Error will be occurred)
2. Firstly make communication Parameter of MP5 series and high order system at one.
3. It is not allow to set overlapping communication number at the same communication line. (Error will be occurred)
4. Please use Twist pair wire for RS485 communication.
5. Communication cable can be extended up to 800m, and maximum 31 equipments can be connected.
6. When connect communication cable between MP5 series and high order system, the vertical resistance(100 to 200Ω) must be installed at between both communication lines.
7. Please check Parameter related to communication
 - ①Start bit : 1bit(Fix)
 - ②Stop bit : 1bit(Fix)
 - ③Parity bit : Non(Fix)
 - ④Data bit : 8bit(Fix)
 - ⑤Baud rate : 2400, 4800, 9600(Set possibility)
 - ⑥Address : 01 to 99(Set possibility)