

Contents

Introduction	1
Safety	1
Performance indexes	2
Product Description	3
Structure	4
Menu Description	5
Battery cover installation method	6
Measurement	7
Focal distance	7
Backlight Settings	7
LED light	7
Color palette	8
Marking of spot temperature	8
Unit of temperature	9
Image mixing	9
Time Setting	9
Image Capture and Storage	10
Check internal storage	10
Notes	10
Emissivity	11
Emissivity of normal materials	11
Maintenance	11

1. Introduction

HT-02 is a thermal Imaging Camera which combines the functions of surface temperature measurement and real-time thermal imaging.

The traditional thermal Imaging Camera shall measure each component one by one but this instrument does not need to. Therefore, it helps to save our customers' time. Even the potential problems can be clearly displayed on the color screen which helps customers quickly locate the central point to measure cursor and temperature.

To improve recognition, this product is equipped with a vision camera. Based on practical requirements, it can turn thermal image into visual image. Thermal image and visual image can be stored in the dismountable memory card. Adjust the images and store them in PC which are used to generate report or for printing. HT-02 is easy to operate. After seconds it can be tested. This product is the optimum product for electrician and maintainer. It can quickly find out the problem area.

The following functions help to improve the accuracy and usability of product:

- Adjustable radiation coefficient and reflection background compensation help to improve the accuracy of the measurement of semi-reflective surface.
- The marking of hot spot and cold spot can help user to locate the hottest and coldest area of thermal imaging temperature.
- Options of color palette

2. Safety

To ensure the accuracy of measured results, please carefully read this manual before operation.

Please strictly follow this manual to operate our product. In case of any problems due to operational errors, the maintenance cost will be charged.

Do not use our product under the explosive or damp or corrosive atmosphere.

If our product is damaged, broken or has just been repaired, the measurement results might be inaccurate.

Please refer to radiation coefficient to get the actual temperature.
 The measured temperature might be lower than the actual temperature because of reflective surface. These surfaces might be the potential burning hazard for user.

3. Performance indexes

Display screen	2.4" full-angle high resolution color screen
Resolution of infrared image	60*60 (3600 pixels)
Resolution of visible image	0.3 mega pixels
Field angle/shortest focal distance	20*20/0.5m
Thermal sensitivity	0.15 °C
Range of temperature measurement	-20°C to +300°C
Accuracy of temperature measurement	±2% or ±2°C (±2% or ±4°F)
Emissivity	Adjustable 0.1-1.0
Image capturing frequency	6Hz
Range of wave length	8-14um
Focal distance	Fixed focal distance
Color palette	Iron red, rainbow, rainbow high contrast, gray scale (black glow) and gray scale (white glow)
Vision option	25% step infrared to visual to infrared and visual image
Memory card	Micro SD card 8 GB
File format	bmp
Power supply	AA battery * 4
Battery life	6 hours
Auto power-off time	12 minutes
Authentication	CE (EN61326-1:2006)
Dimension of product (L*W*H)	212mm*95mm*62mm
Weight	320g
Warranty period	1 years
Operating temperature	-5°C to +40°C
Storage temperature	-20°C to +50°C
Relative humidity	10% RH to 80% RH

4. Product description

Press “tart-up” key for 5 seconds and the instrument starts up.
 Press “menu” key for 1 second to enter into the mode of the setting of basic functions. There are only five options on the display screen.
 Press “up” or “down” key to scan the menu and select the yellow option box.
 Press “select” key and select “menu” option and edit the value.
 Press “up” or “down” key to edit the value. After adjustment, confirm the new value and press “menu” key to exit the edit mode.

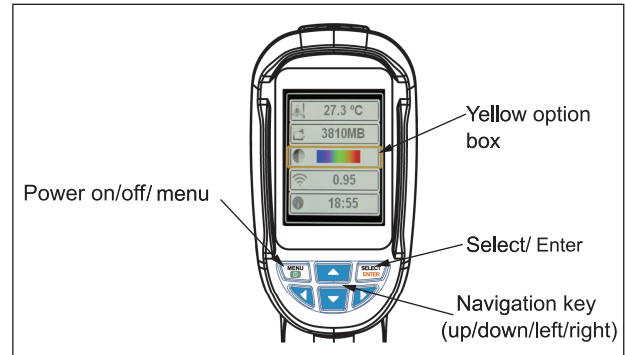

Figure 1- Basic Functions

5. Structure

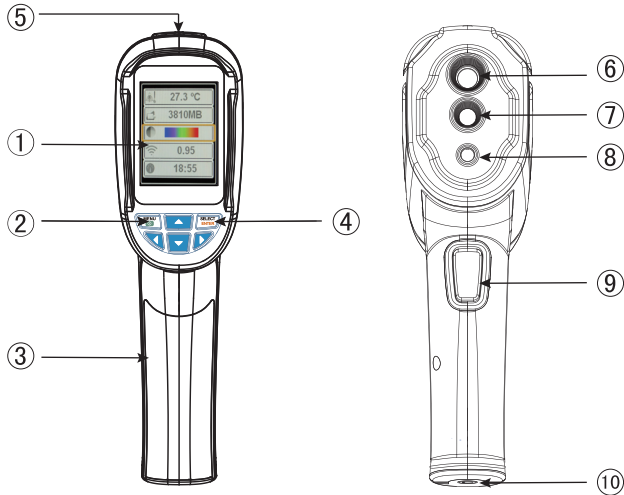

Figure 2 – Structure of Product

Item	Description	Item	Description
1	TFT high definition color screen	6	Infrared imaging sensor
2	Start-up/menu key	7	Visual light camera
3	Battery cover	8	LED
4	Select/enter key	9	Image capturing key
5	Micro SD card	10	Interface for the installation of tripod

6. Menu Description

Icon	Description
°C	Temperature unit setting : °C/°F
0°C	Default setting : 0°C/32°F
8GB	Capacity of memory card
	Color palette setting
0.95	Emissivity setting : 0.1~1.0
ON	Marking of spot temperature
25°C	Ambient temperature
12:12	Time setting
5000	Save image
10%	Background light setting

Figure 3 –Menu's Icons and Description

7. Battery cover installation method

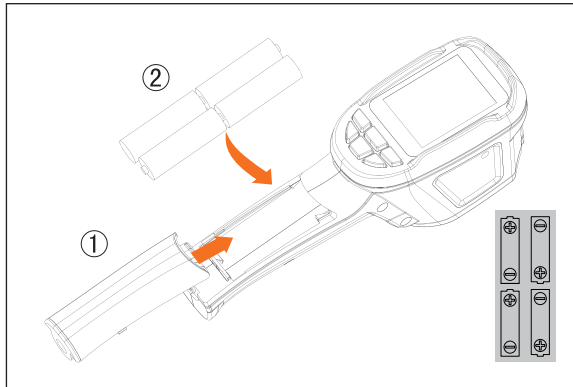
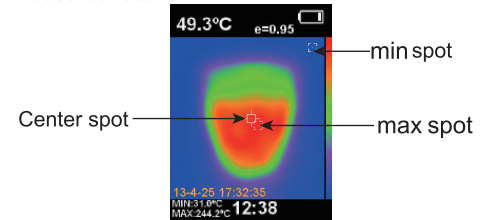

Figure 4 – Replace Battery

1. Do not mistakenly install the battery.
2. Slide the battery cover to the accurate position.

8. Measurement

The measured temperature of the center of pixel is displayed in the upper left corner of display screen. The setting of radiation coefficient is also displayed in the upper right corner of display screen. Move the product until hot spot or cold spot coincides with the center of pixel. Direct the product to the object whose temperature is higher or lower than the surrounding temperature to get the optimum measured results.



9. Focal distance

This product is the fixed-focal thermal Imaging Camera. The applicable distance is 50cm (20 in).

10. Backlight Settings

Enter the menu mode, press the SELECT key to choose the backlight menu, then press the up and down key to adjust backlight brightness, the default brightness is 10%.

11. LED light

Press “image capturing” key for 5 seconds to turn on LED light to cooperate with the working of visible camera.

12. Color palette

“Color palette” menu can change the fake color of the infrared image displayed on the screen or captured. A series of color palette is available for usage. Some color palettes are more applicable to the special areas, so they are set as required options. Gray-scale color palette provides balanced linear color, so it can help to fully reveal details. High-contrast color palette can emphasize the displayed color. This color palette is applicable to the hot-cold contrast situation. It is used to improve the color contrast of high-temperature and low-temperature. Iron red and rainbow color palettes provide a mixed high-contrast gray-scale color palette.

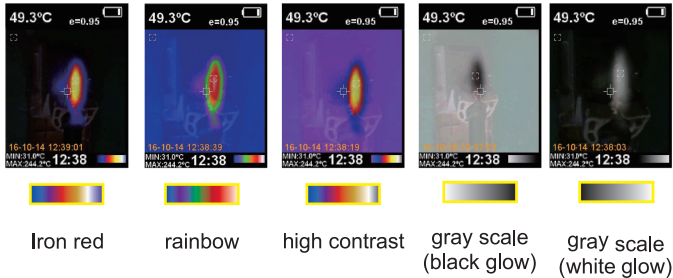

13. Marking of spot temperature

Press the MENU button to enter the MENU mode, and then press the up and down key to choose the point temperature tag MENU, press the SELECT key and then press the up key to open and close the point temperature tag. If turning on, the marking of spot temperature indicates that the hot spot or cold spot in the screen needs additional appraisal. If turning off, it indicates that user can focus on the measured pixel per time.

14. Unit of temperature

The product displays the temperature in unit of °C or °F.

15. Image mixing

Use the aligned visible image and infrared image become. The mixed image makes the understanding of infrared image become easier. The product can capture the visible image of each infrared image to accurately display the temperature distribution of target area. It helps to share with others. If this mixing function is used, press “left” or “right” key to adjust the mixed image from 0% to 100%.

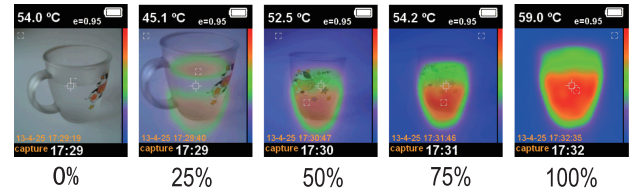

16. Time setting

In clock menu, use can set time and date. Press “menu” key to enter into “menu” mode. Press “up” or “down” key to select “clock” menu. Press “select” key to enter into the mode of clock calibration. Press “left” or “right” key to select the aimed time parameter. Press “up” or “down” key to add or subtract the value. After setting, press “menu” key to exit.

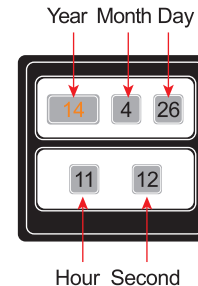

17. Image Capture and Storage

This product can be stored for up to 12,500 images on the micro SD card. Press image capturing button and the symbol of “store photos yes no” will display on the screen, Press “MENU” key to store image. Press “SELECT” key to delete the captured image. If “NO SD” displayed at the lower left corner of screen, it indicates SD card is not installed. If “FULL” is displayed at the lower left corner of screen, it indicates that SD card is full.

18. Check internal storage

1. Press “menu” key to enter into the mode of “menu”.
2. Select the image storage module using the arrow keys.
3. Press the “SELECT” button to select the picture you want to view.
4. Press the arrow keys to view other pictures.
5. Press the SELECT button to view pictures.
6. Press the above key on the screen will display "Delet photo yes no", then press the MENU key to delete the picture, Press "SELECT" to cancel.
7. Press the MENU button to exit Review.

19. Notes

All the objects have the radiated infrared energy. The radiated quantity of infrared energy is based on the actual temperature and radiation coefficient of surface. Our instrument can sense the infrared energy on the surface of object and estimate the temperature based on the sensed value of infrared energy. Many objects (e.g. coated metal, wood, water, skin and texture) can radiate energy, so it is easy to get the accurate measured value. As to the surface which is easy to radiate energy (high radiation coefficient), the radiation coefficient is greater than 90% (0.90). This simple method is not applicable to the glossy surface or coated metal because their radiation coefficient is less than 60% (0.06). These materials are not easy to radiate energy so they are classified as the low radiation coefficient materials. To accurately measure the low radiation coefficient materials, calibrate the radiation coefficient. Adjustment of radiation coefficient is to make the product more accurately calculate the estimated value of actual temperature.

20. Emissivity

For the emissivity within the step length of 0.01, it can be adjusted from 0.10 to 1.00. Set the default value to 0.95. The accurate value of emissivity is very important to the accurate measurement of temperature. The surface emissivity has great impact on the measured temperature of our product. To know the emissivity of the measured surface helps to get more accurate result of temperature but this is not always true.

21. Emissivity of normal materials

Materials	Thermal radiation	Materials	Thermal radiation
Asphalt	0.90~0.98	Black cloth	0.98
Concrete	0.94	Human skin	0.98
Cement	0.96	Bubble	0.75~0.80
Sand	0.90	Charcoal dust	0.96
Soil	0.92~0.96	Paint	0.80~0.95
Water	0.92~0.96	Matt paint	0.97
Ice	0.96~0.98	Black rubber	0.94
Snow	0.83	Plastic	0.85~0.95
Glass	0.90~0.95	Wood	0.90
Ceramic	0.90~0.94	Paper	0.70~0.94
Marble	0.94	Chromic oxide	0.81
Gypsum	0.80~0.90	Copper oxide	0.78
Mortar	0.89~0.91	Ferric oxide	0.78~0.82
Brick	0.93~0.96	Texture	0.90

22. Maintenance

Use wet cloth or liquid soap to clean the shell. Do not use abrasive compound or isopropyl alcohol or solvent to clean the shell or lens or window.