

LM741 Operational Amplifier

1 Features

- Overload Protection on the Input and Output
- No Latch-Up When the Common-Mode Range is Exceeded

2 Applications

- Comparators
- Multivibrators
- DC Amplifiers
- Summing Amplifiers
- Integrator or Differentiators
- Active Filters

3 Description

The LM741 series are general-purpose operational amplifiers which feature improved performance over industry standards like the LM709. They are direct, plug-in replacements for the 709C, LM201, MC1439, and 748 in most applications.

The amplifiers offer many features which make their application nearly foolproof: overload protection on the input and output, no latch-up when the common-mode range is exceeded, as well as freedom from oscillations.

The LM741C is identical to the LM741 and LM741A except that the LM741C has their performance ensured over a 0°C to +70°C temperature range, instead of -55°C to +125°C.

Device Information⁽¹⁾

PART NUMBER	PACKAGE	BODY SIZE (NOM)
LM741	TO-99 (8)	9.08 mm × 9.08 mm
	CDIP (8)	10.16 mm × 6.502 mm
	PDIP (8)	9.81 mm × 6.35 mm

(1) For all available packages, see the orderable addendum at the end of the data sheet.

Typical Application

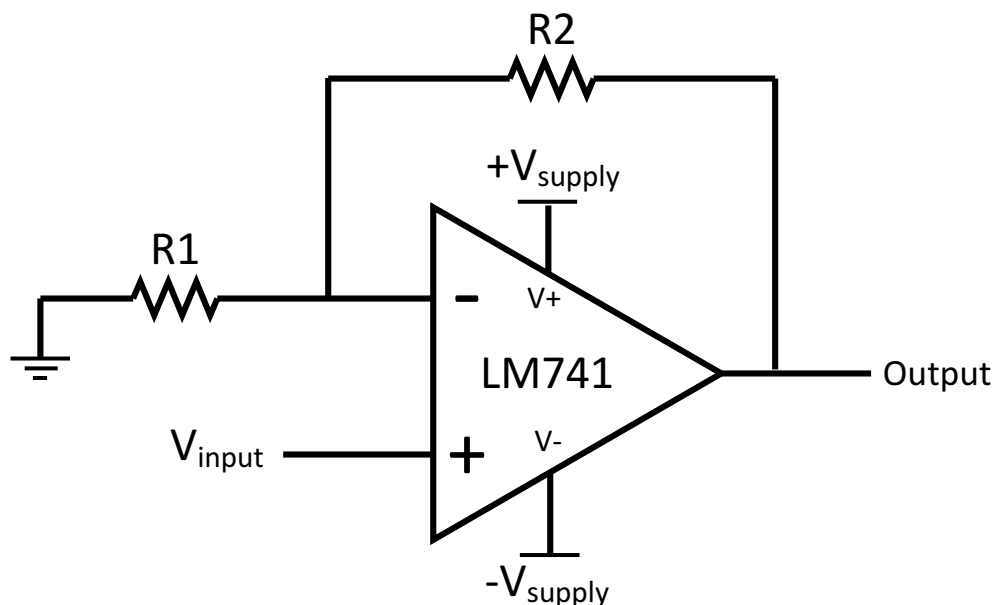

Table of Contents

1 Features 1 2 Applications 1 3 Description 1 4 Revision History 2 5 Pin Configuration and Functions 3 6 Specifications 4 6.1 Absolute Maximum Ratings 4 6.2 ESD Ratings 4 6.3 Recommended Operating Conditions 4 6.4 Thermal Information 4 6.5 Electrical Characteristics, LM741 5 6.6 Electrical Characteristics, LM741A 5 6.7 Electrical Characteristics, LM741C 6 7 Detailed Description 7 7.1 Overview 7 7.2 Functional Block Diagram 7	7.3 Feature Description 7 7.4 Device Functional Modes 8 8 Application and Implementation 9 8.1 Application Information 9 8.2 Typical Application 9 9 Power Supply Recommendations 10 10 Layout 11 10.1 Layout Guidelines 11 10.2 Layout Example 11 11 Device and Documentation Support 12 11.1 Community Resources 12 11.2 Trademarks 12 11.3 Electrostatic Discharge Caution 12 11.4 Glossary 12 12 Mechanical, Packaging, and Orderable Information 12
--	---

4 Revision History

NOTE: Page numbers for previous revisions may differ from page numbers in the current version.

Changes from Revision C (October 2004) to Revision D	Page
• Added <i>Applications</i> section, <i>Pin Configuration and Functions</i> section, <i>ESD Ratings</i> table, <i>Feature Description</i> section, <i>Device Functional Modes</i> , <i>Application and Implementation</i> section, <i>Power Supply Recommendations</i> section, <i>Layout</i> section, <i>Device and Documentation Support</i> section, and <i>Mechanical, Packaging, and Orderable Information</i> section	1
• Removed NAD 10-Pin CLGA pinout	3
• Removed obsolete M (S0-8) package from the data sheet	4
• Added recommended operating supply voltage spec	4
• Added recommended operating temperature spec	4

Changes from Revision C (March 2013) to Revision D	Page
• Added <i>Applications</i> section, <i>Pin Configuration and Functions</i> section, <i>ESD Ratings</i> table, <i>Feature Description</i> section, <i>Device Functional Modes</i> , <i>Application and Implementation</i> section, <i>Power Supply Recommendations</i> section, <i>Layout</i> section, <i>Device and Documentation Support</i> section, and <i>Mechanical, Packaging, and Orderable Information</i> section	1
• Removed NAD 10-Pin CLGA pinout	3
• Removed obsolete M (S0-8) package from the data sheet	4
• Added recommended operating supply voltage spec	4
• Added recommended operating temperature spec	4

5 Pin Configuration and Functions

LMC Package
8-Pin TO-99
Top View

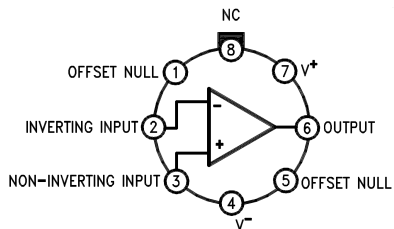

LM741H is available per JM38510/10101

NAB Package
8-Pin CDIP or PDIP
Top View

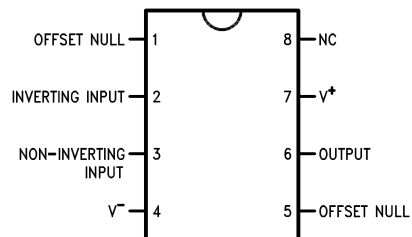

Pin Functions

PIN		I/O	DESCRIPTION
NAME	NO.		
INVERTING INPUT	2	I	Inverting signal input
NC	8	N/A	No Connect, should be left floating
NONINVERTING INPUT	3	I	Noninverting signal input
OFFSET NULL	1, 5	I	Offset null pin used to eliminate the offset voltage and balance the input voltages.
OFFSET NULL			
OUTPUT	6	O	Amplified signal output
V+	7	I	Positive supply voltage
V-	4	I	Negative supply voltage

6 Specifications

6.1 Absolute Maximum Ratings

 over operating free-air temperature range (unless otherwise noted)⁽¹⁾⁽²⁾⁽³⁾

		MIN	MAX	UNIT
Supply voltage	LM741, LM741A	±22		V
	LM741C	±18		
Power dissipation ⁽⁴⁾		500		mW
Differential input voltage		±30		V
Input voltage ⁽⁵⁾		±15		V
Output short circuit duration		Continuous		
Operating temperature	LM741, LM741A	-50	125	°C
	LM741C	0	70	
Junction temperature	LM741, LM741A	150		°C
	LM741C	100		
Soldering information	PDIP package (10 seconds)	260		°C
	CDIP or TO-99 package (10 seconds)	300		°C
Storage temperature, T _{stg}		-65	150	°C

- Stresses beyond those listed under *Absolute Maximum Ratings* may cause permanent damage to the device. These are stress ratings only, which do not imply functional operation of the device at these or any other conditions beyond those indicated under *Recommended Operating Conditions*. Exposure to absolute-maximum-rated conditions for extended periods may affect device reliability.
- For military specifications see RETS741X for LM741 and RETS741AX for LM741A.
- If Military/Aerospace specified devices are required, please contact the TI Sales Office/Distributors for availability and specifications.
- For operation at elevated temperatures, these devices must be derated based on thermal resistance, and T_j max. (listed under "Absolute Maximum Ratings"). $T_j = T_A + (\theta_{JA} P_D)$.
- For supply voltages less than ±15 V, the absolute maximum input voltage is equal to the supply voltage.

6.2 ESD Ratings

			VALUE	UNIT
V _(ESD)	Electrostatic discharge	Human body model (HBM), per ANSI/ESDA/JEDEC JS-001 ⁽¹⁾	±400	V

- Level listed above is the passing level per ANSI, ESDA, and JEDEC JS-001. JEDEC document JEP155 states that 500-V HBM allows safe manufacturing with a standard ESD control process.

6.3 Recommended Operating Conditions

over operating free-air temperature range (unless otherwise noted)

		MIN	NOM	MAX	UNIT
Supply voltage (VDD-GND)	LM741, LM741A	±10	±15	±22	V
	LM741C	±10	±15	±18	
Temperature	LM741, LM741A	-55		125	°C
	LM741C	0		70	

6.4 Thermal Information

THERMAL METRIC ⁽¹⁾	LM741			UNIT
	LMC (TO-99)	NAB (CDIP)	P (PDIP)	
	8 PINS	8 PINS	8 PINS	
R _{θJA} Junction-to-ambient thermal resistance	170	100	100	°C/W
R _{θJC(top)} Junction-to-case (top) thermal resistance	25	—	—	°C/W

- For more information about traditional and new thermal metrics, see the *Semiconductor and IC Package Thermal Metrics* application report, [SPRA953](#).

6.5 Electrical Characteristics, LM741⁽¹⁾

PARAMETER		TEST CONDITIONS	MIN	TYP	MAX	UNIT
Input offset voltage	$R_S \leq 10 \text{ k}\Omega$	$T_A = 25^\circ\text{C}$		1	5	mV
		$T_{AMIN} \leq T_A \leq T_{AMAX}$			6	mV
Input offset voltage adjustment range	$T_A = 25^\circ\text{C}, V_S = \pm 20 \text{ V}$			± 15		mV
Input offset current	$T_A = 25^\circ\text{C}$ $T_{AMIN} \leq T_A \leq T_{AMAX}$			20	200	nA
				85	500	
Input bias current	$T_A = 25^\circ\text{C}$ $T_{AMIN} \leq T_A \leq T_{AMAX}$			80	500	nA
					1.5	μA
Input resistance	$T_A = 25^\circ\text{C}, V_S = \pm 20 \text{ V}$		0.3	2		M Ω
Input voltage range	$T_{AMIN} \leq T_A \leq T_{AMAX}$		± 12	± 13		V
Large signal voltage gain	$V_S = \pm 15 \text{ V}, V_O = \pm 10 \text{ V}, R_L \geq 2 \text{ k}\Omega$	$T_A = 25^\circ\text{C}$	50	200		V/mV
		$T_{AMIN} \leq T_A \leq T_{AMAX}$	25			
Output voltage swing	$V_S = \pm 15 \text{ V}$	$R_L \geq 10 \text{ k}\Omega$	± 12	± 14		V
		$R_L \geq 2 \text{ k}\Omega$	± 10	± 13		
Output short circuit current	$T_A = 25^\circ\text{C}$			25		mA
Common-mode rejection ratio	$R_S \leq 10 \Omega, V_{CM} = \pm 12 \text{ V}, T_{AMIN} \leq T_A \leq T_{AMAX}$		80	95		dB
Supply voltage rejection ratio	$V_S = \pm 20 \text{ V}$ to $V_S = \pm 5 \text{ V}, R_S \leq 10 \Omega, T_{AMIN} \leq T_A \leq T_{AMAX}$		86	96		dB
Transient response	Rise time	$T_A = 25^\circ\text{C},$ unity gain		0.3		μs
	Overshoot			5%		
Slew rate	$T_A = 25^\circ\text{C},$ unity gain			0.5		V/ μs
Supply current	$T_A = 25^\circ\text{C}$			1.7	2.8	mA
Power consumption	$V_S = \pm 15 \text{ V}$	$T_A = 25^\circ\text{C}$		50	85	mW
		$T_A = T_{AMIN}$		60	100	
		$T_A = T_{AMAX}$		45	75	

(1) Unless otherwise specified, these specifications apply for $V_S = \pm 15 \text{ V}, -55^\circ\text{C} \leq T_A \leq +125^\circ\text{C}$ (LM741/LM741A). For the LM741C/LM741E, these specifications are limited to $0^\circ\text{C} \leq T_A \leq +70^\circ\text{C}$.

6.6 Electrical Characteristics, LM741A⁽¹⁾

PARAMETER		TEST CONDITIONS	MIN	TYP	MAX	UNIT
Input offset voltage	$R_S \leq 50 \Omega$	$T_A = 25^\circ\text{C}$		0.8	3	mV
		$T_{AMIN} \leq T_A \leq T_{AMAX}$			4	mV
Average input offset voltage drift					15	$\mu\text{V}/^\circ\text{C}$
Input offset voltage adjustment range	$T_A = 25^\circ\text{C}, V_S = \pm 20 \text{ V}$		± 10			mV
Input offset current	$T_A = 25^\circ\text{C}$ $T_{AMIN} \leq T_A \leq T_{AMAX}$			3	30	nA
					70	
Average input offset current drift					0.5	nA/ $^\circ\text{C}$
Input bias current	$T_A = 25^\circ\text{C}$ $T_{AMIN} \leq T_A \leq T_{AMAX}$			30	80	nA
					0.21	μA
Input resistance	$T_A = 25^\circ\text{C}, V_S = \pm 20 \text{ V}$ $T_{AMIN} \leq T_A \leq T_{AMAX}, V_S = \pm 20 \text{ V}$		1	6		M Ω
			0.5			
Large signal voltage gain	$V_S = \pm 20 \text{ V}, V_O = \pm 15 \text{ V}, R_L \geq 2 \text{ k}\Omega$	$T_A = 25^\circ\text{C}$	50			V/mV
		$T_{AMIN} \leq T_A \leq T_{AMAX}$	32			
		$V_S = \pm 5 \text{ V}, V_O = \pm 2 \text{ V}, R_L \geq 2 \text{ k}\Omega, T_{AMIN} \leq T_A \leq T_{AMAX}$	10			

(1) Unless otherwise specified, these specifications apply for $V_S = \pm 15 \text{ V}, -55^\circ\text{C} \leq T_A \leq +125^\circ\text{C}$ (LM741/LM741A). For the LM741C/LM741E, these specifications are limited to $0^\circ\text{C} \leq T_A \leq +70^\circ\text{C}$.

Electrical Characteristics, LM741A⁽¹⁾ (continued)

PARAMETER		TEST CONDITIONS	MIN	TYP	MAX	UNIT
Output voltage swing	$V_S = \pm 20\text{ V}$	$R_L \geq 10\text{ k}\Omega$	± 16			V
		$R_L \geq 2\text{ k}\Omega$	± 15			
Output short circuit current	$T_A = 25^\circ\text{C}$		10	25	35	mA
	$T_{AMIN} \leq T_A \leq T_{AMAX}$		10		40	
Common-mode rejection ratio	$R_S \leq 50\ \Omega$, $V_{CM} = \pm 12\text{ V}$, $T_{AMIN} \leq T_A \leq T_{AMAX}$		80	95		dB
Supply voltage rejection ratio	$V_S = \pm 20\text{ V}$ to $V_S = \pm 5\text{ V}$, $R_S \leq 50\ \Omega$, $T_{AMIN} \leq T_A \leq T_{AMAX}$		86	96		dB
Transient response	Rise time	$T_A = 25^\circ\text{C}$, unity gain		0.25	0.8	μs
	Overshoot			6%	20%	
Bandwidth ⁽²⁾	$T_A = 25^\circ\text{C}$		0.437	1.5		MHz
Slew rate	$T_A = 25^\circ\text{C}$, unity gain		0.3	0.7		V/ μs
Power consumption	$V_S = \pm 20\text{ V}$	$T_A = 25^\circ\text{C}$		80	150	mW
		$T_A = T_{AMIN}$			165	
		$T_A = T_{AMAX}$			135	

(2) Calculated value from: BW (MHz) = 0.35/Rise Time (μs).

6.7 Electrical Characteristics, LM741C⁽¹⁾

PARAMETER		TEST CONDITIONS	MIN	TYP	MAX	UNIT
Input offset voltage	$R_S \leq 10\text{ k}\Omega$	$T_A = 25^\circ\text{C}$		2	6	mV
		$T_{AMIN} \leq T_A \leq T_{AMAX}$			7.5	mV
Input offset voltage adjustment range	$T_A = 25^\circ\text{C}$, $V_S = \pm 20\text{ V}$			± 15		mV
Input offset current	$T_A = 25^\circ\text{C}$			20	200	nA
	$T_{AMIN} \leq T_A \leq T_{AMAX}$				300	
Input bias current	$T_A = 25^\circ\text{C}$			80	500	nA
	$T_{AMIN} \leq T_A \leq T_{AMAX}$				0.8	
Input resistance	$T_A = 25^\circ\text{C}$, $V_S = \pm 20\text{ V}$		0.3	2		M Ω
Input voltage range	$T_A = 25^\circ\text{C}$		± 12	± 13		V
Large signal voltage gain	$V_S = \pm 15\text{ V}$, $V_O = \pm 10\text{ V}$, $R_L \geq 2\text{ k}\Omega$	$T_A = 25^\circ\text{C}$	20	200		V/mV
		$T_{AMIN} \leq T_A \leq T_{AMAX}$	15			
Output voltage swing	$V_S = \pm 15\text{ V}$	$R_L \geq 10\text{ k}\Omega$	± 12	± 14		V
		$R_L \geq 2\text{ k}\Omega$	± 10	± 13		
Output short circuit current	$T_A = 25^\circ\text{C}$			25		mA
Common-mode rejection ratio	$R_S \leq 10\text{ k}\Omega$, $V_{CM} = \pm 12\text{ V}$, $T_{AMIN} \leq T_A \leq T_{AMAX}$		70	90		dB
Supply voltage rejection ratio	$V_S = \pm 20\text{ V}$ to $V_S = \pm 5\text{ V}$, $R_S \leq 10\ \Omega$, $T_{AMIN} \leq T_A \leq T_{AMAX}$		77	96		dB
Transient response	Rise time	$T_A = 25^\circ\text{C}$, Unity Gain		0.3		μs
	Overshoot			5%		
Slew rate	$T_A = 25^\circ\text{C}$, Unity Gain			0.5		V/ μs
Supply current	$T_A = 25^\circ\text{C}$			1.7	2.8	mA
Power consumption	$V_S = \pm 15\text{ V}$, $T_A = 25^\circ\text{C}$			50	85	mW

(1) Unless otherwise specified, these specifications apply for $V_S = \pm 15\text{ V}$, $-55^\circ\text{C} \leq T_A \leq +125^\circ\text{C}$ (LM741/LM741A). For the LM741C/LM741E, these specifications are limited to $0^\circ\text{C} \leq T_A \leq +70^\circ\text{C}$.

7 Detailed Description

7.1 Overview

The LM741 devices are general-purpose operational amplifiers which feature improved performance over industry standards like the LM709. It is intended for a wide range of analog applications. The high gain and wide range of operating voltage provide superior performance in integrator, summing amplifier, and general feedback applications. The LM741 can operate with a single or dual power supply voltage. The LM741 devices are direct, plug-in replacements for the 709C, LM201, MC1439, and 748 in most applications.

7.2 Functional Block Diagram

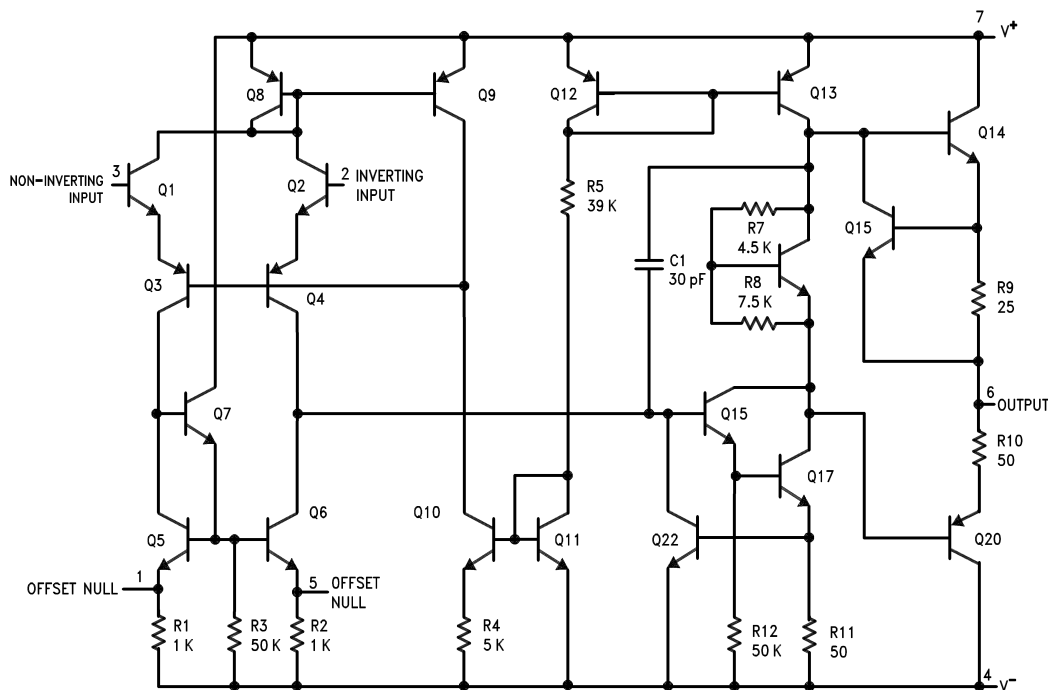

7.3 Feature Description

7.3.1 Overload Protection

The LM741 features overload protection circuitry on the input and output. This prevents possible circuit damage to the device.

7.3.2 Latch-up Prevention

The LM741 is designed so that there is no latch-up occurrence when the common-mode range is exceeded. This allows the device to function properly without having to power cycle the device.

7.3.3 Pin-to-Pin Capability

The LM741 is pin-to-pin direct replacements for the LM709C, LM201, MC1439, and LM748 in most applications. Direct replacement capabilities allows flexibility in design for replacing obsolete parts.

7.4 Device Functional Modes

7.4.1 Open-Loop Amplifier

The LM741 can be operated in an open-loop configuration. The magnitude of the open-loop gain is typically large thus for a small difference between the noninverting and inverting input terminals, the amplifier output will be driven near the supply voltage. Without negative feedback, the LM741 can act as a comparator. If the inverting input is held at 0 V, and the input voltage applied to the noninverting input is positive, the output will be positive. If the input voltage applied to the noninverting input is negative, the output will be negative.

7.4.2 Closed-Loop Amplifier

In a closed-loop configuration, negative feedback is used by applying a portion of the output voltage to the inverting input. Unlike the open-loop configuration, closed loop feedback reduces the gain of the circuit. The overall gain and response of the circuit is determined by the feedback network rather than the operational amplifier characteristics. The response of the operational amplifier circuit is characterized by the transfer function.

8 Application and Implementation

NOTE

Information in the following applications sections is not part of the TI component specification, and TI does not warrant its accuracy or completeness. TI's customers are responsible for determining suitability of components for their purposes. Customers should validate and test their design implementation to confirm system functionality.

8.1 Application Information

The LM741 is a general-purpose amplifier that can be used in a variety of applications and configurations. One common configuration is in a noninverting amplifier configuration. In this configuration, the output signal is in phase with the input (not inverted as in the inverting amplifier configuration), the input impedance of the amplifier is high, and the output impedance is low. The characteristics of the input and output impedance is beneficial for applications that require isolation between the input and output. No significant loading will occur from the previous stage before the amplifier. The gain of the system is set accordingly so the output signal is a factor larger than the input signal.

8.2 Typical Application

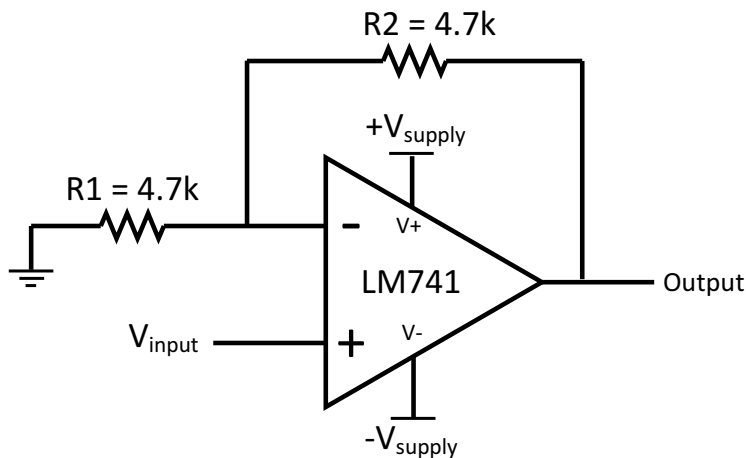

Figure 1. LM741 Noninverting Amplifier Circuit

8.2.1 Design Requirements

As shown in [Figure 1](#), the signal is applied to the noninverting input of the LM741. The gain of the system is determined by the feedback resistor and input resistor connected to the inverting input. The gain can be calculated by [Equation 1](#):

$$\text{Gain} = 1 + (R2/R1) \quad (1)$$

The gain is set to 2 for this application. R1 and R2 are 4.7-k resistors with 5% tolerance.

8.2.2 Detailed Design Procedure

The LM741 can be operated in either single supply or dual supply. This application is configured for dual supply with the supply rails at ± 15 V. The input signal is connected to a function generator. A 1-V_{pp}, 10-kHz sine wave was used as the signal input. 5% tolerance resistors were used, but if the application requires an accurate gain response, use 1% tolerance resistors.

Typical Application (continued)

8.2.3 Application Curve

The waveforms in [Figure 2](#) show the input and output signals of the LM741 non-inverting amplifier circuit. The blue waveform (top) shows the input signal, while the red waveform (bottom) shows the output signal. The input signal is 1.06 V_{pp} and the output signal is 1.94 V_{pp}. With the 4.7-kΩ resistors, the theoretical gain of the system is 2. Due to the 5% tolerance, the gain of the system including the tolerance is 1.992. The gain of the system when measured from the mean amplitude values on the oscilloscope was 1.83.

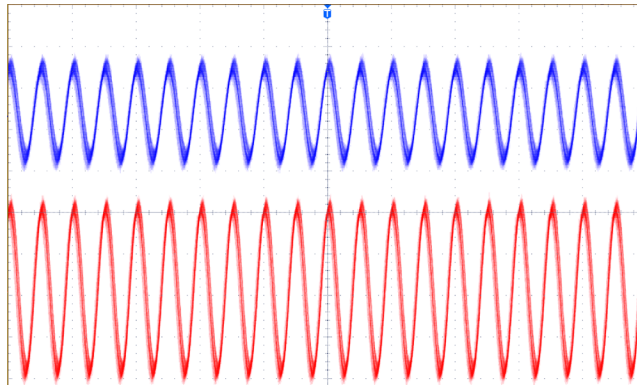

Figure 2. Waveforms for LM741 Noninverting Amplifier Circuit

9 Power Supply Recommendations

For proper operation, the power supplies must be properly decoupled. For decoupling the supply lines, a 0.1-μF capacitor is recommended and should be placed as close as possible to the LM741 power supply pins.

10 Layout

10.1 Layout Guidelines

As with most amplifiers, take care with lead dress, component placement, and supply decoupling in order to ensure stability. For example, resistors from the output to an input should be placed with the body close to the input to minimize pick-up and maximize the frequency of the feedback pole by minimizing the capacitance from the input to ground. As shown in Figure 3, the feedback resistors and the decoupling capacitors are located close to the device to ensure maximum stability and noise performance of the system.

10.2 Layout Example

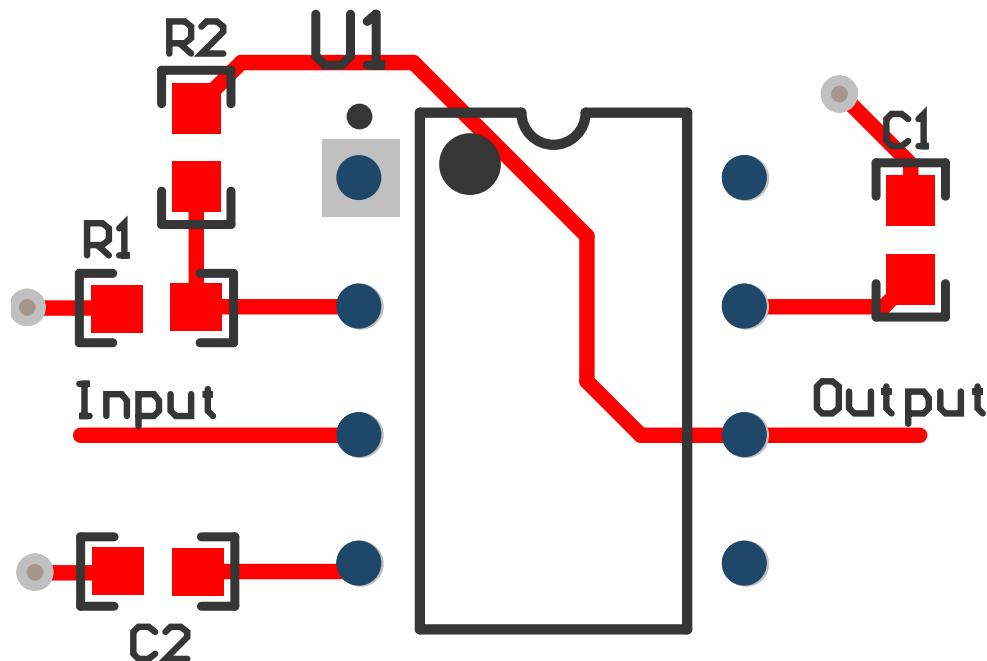

Figure 3. LM741 Layout

11 Device and Documentation Support

11.1 Community Resources

The following links connect to TI community resources. Linked contents are provided "AS IS" by the respective contributors. They do not constitute TI specifications and do not necessarily reflect TI's views; see TI's [Terms of Use](#).

TI E2E™ Online Community *TI's Engineer-to-Engineer (E2E) Community*. Created to foster collaboration among engineers. At e2e.ti.com, you can ask questions, share knowledge, explore ideas and help solve problems with fellow engineers.

Design Support *TI's Design Support* Quickly find helpful E2E forums along with design support tools and contact information for technical support.

11.2 Trademarks

E2E is a trademark of Texas Instruments.
All other trademarks are the property of their respective owners.

11.3 Electrostatic Discharge Caution



These devices have limited built-in ESD protection. The leads should be shorted together or the device placed in conductive foam during storage or handling to prevent electrostatic damage to the MOS gates.

11.4 Glossary

[SLYZ022](#) — *TI Glossary*.

This glossary lists and explains terms, acronyms, and definitions.

12 Mechanical, Packaging, and Orderable Information

The following pages include mechanical, packaging, and orderable information. This information is the most current data available for the designated devices. This data is subject to change without notice and revision of this document. For browser-based versions of this data sheet, refer to the left-hand navigation.

PACKAGING INFORMATION

Orderable Device	Status (1)	Package Type	Package Drawing	Pins	Package Qty	Eco Plan (2)	Lead/Ball Finish (6)	MSL Peak Temp (3)	Op Temp (°C)	Device Marking (4/5)	Samples
LM741C-MWC	ACTIVE	WAFERSALE	YS	0	1	Green (RoHS & no Sb/Br)	Call TI	Level-1-NA-UNLIM	-40 to 85		Samples
LM741CN/NOPB	ACTIVE	PDIP	P	8	40	Green (RoHS & no Sb/Br)	CU SN	Level-1-NA-UNLIM	0 to 70	LM 741CN	Samples

(1) The marketing status values are defined as follows:

ACTIVE: Product device recommended for new designs.

LIFEBUY: TI has announced that the device will be discontinued, and a lifetime-buy period is in effect.

NRND: Not recommended for new designs. Device is in production to support existing customers, but TI does not recommend using this part in a new design.

PREVIEW: Device has been announced but is not in production. Samples may or may not be available.

OBSOLETE: TI has discontinued the production of the device.

(2) **RoHS:** TI defines "RoHS" to mean semiconductor products that are compliant with the current EU RoHS requirements for all 10 RoHS substances, including the requirement that RoHS substance do not exceed 0.1% by weight in homogeneous materials. Where designed to be soldered at high temperatures, "RoHS" products are suitable for use in specified lead-free processes. TI may reference these types of products as "Pb-Free".

RoHS Exempt: TI defines "RoHS Exempt" to mean products that contain lead but are compliant with EU RoHS pursuant to a specific EU RoHS exemption.

Green: TI defines "Green" to mean the content of Chlorine (Cl) and Bromine (Br) based flame retardants meet JS709B low halogen requirements of <=1000ppm threshold. Antimony trioxide based flame retardants must also meet the <=1000ppm threshold requirement.

(3) MSL, Peak Temp. - The Moisture Sensitivity Level rating according to the JEDEC industry standard classifications, and peak solder temperature.

(4) There may be additional marking, which relates to the logo, the lot trace code information, or the environmental category on the device.

(5) Multiple Device Markings will be inside parentheses. Only one Device Marking contained in parentheses and separated by a "~" will appear on a device. If a line is indented then it is a continuation of the previous line and the two combined represent the entire Device Marking for that device.

(6) Lead/Ball Finish - Orderable Devices may have multiple material finish options. Finish options are separated by a vertical ruled line. Lead/Ball Finish values may wrap to two lines if the finish value exceeds the maximum column width.

Important Information and Disclaimer:The information provided on this page represents TI's knowledge and belief as of the date that it is provided. TI bases its knowledge and belief on information provided by third parties, and makes no representation or warranty as to the accuracy of such information. Efforts are underway to better integrate information from third parties. TI has taken and continues to take reasonable steps to provide representative and accurate information but may not have conducted destructive testing or chemical analysis on incoming materials and chemicals. TI and TI suppliers consider certain information to be proprietary, and thus CAS numbers and other limited information may not be available for release.

In no event shall TI's liability arising out of such information exceed the total purchase price of the TI part(s) at issue in this document sold by TI to Customer on an annual basis.

P (R-PDIP-T8)

PLASTIC DUAL-IN-LINE PACKAGE



- NOTES:
- A. All linear dimensions are in inches (millimeters).
 - B. This drawing is subject to change without notice.
 - C. Falls within JEDEC MS-001 variation BA.

IMPORTANT NOTICE

Texas Instruments Incorporated (TI) reserves the right to make corrections, enhancements, improvements and other changes to its semiconductor products and services per JESD46, latest issue, and to discontinue any product or service per JESD48, latest issue. Buyers should obtain the latest relevant information before placing orders and should verify that such information is current and complete.

TI's published terms of sale for semiconductor products (<http://www.ti.com/sc/docs/stdterms.htm>) apply to the sale of packaged integrated circuit products that TI has qualified and released to market. Additional terms may apply to the use or sale of other types of TI products and services.

Reproduction of significant portions of TI information in TI data sheets is permissible only if reproduction is without alteration and is accompanied by all associated warranties, conditions, limitations, and notices. TI is not responsible or liable for such reproduced documentation. Information of third parties may be subject to additional restrictions. Resale of TI products or services with statements different from or beyond the parameters stated by TI for that product or service voids all express and any implied warranties for the associated TI product or service and is an unfair and deceptive business practice. TI is not responsible or liable for any such statements.

Buyers and others who are developing systems that incorporate TI products (collectively, "Designers") understand and agree that Designers remain responsible for using their independent analysis, evaluation and judgment in designing their applications and that Designers have full and exclusive responsibility to assure the safety of Designers' applications and compliance of their applications (and of all TI products used in or for Designers' applications) with all applicable regulations, laws and other applicable requirements. Designer represents that, with respect to their applications, Designer has all the necessary expertise to create and implement safeguards that (1) anticipate dangerous consequences of failures, (2) monitor failures and their consequences, and (3) lessen the likelihood of failures that might cause harm and take appropriate actions. Designer agrees that prior to using or distributing any applications that include TI products, Designer will thoroughly test such applications and the functionality of such TI products as used in such applications.

TI's provision of technical, application or other design advice, quality characterization, reliability data or other services or information, including, but not limited to, reference designs and materials relating to evaluation modules, (collectively, "TI Resources") are intended to assist designers who are developing applications that incorporate TI products; by downloading, accessing or using TI Resources in any way, Designer (individually or, if Designer is acting on behalf of a company, Designer's company) agrees to use any particular TI Resource solely for this purpose and subject to the terms of this Notice.

TI's provision of TI Resources does not expand or otherwise alter TI's applicable published warranties or warranty disclaimers for TI products, and no additional obligations or liabilities arise from TI providing such TI Resources. TI reserves the right to make corrections, enhancements, improvements and other changes to its TI Resources. TI has not conducted any testing other than that specifically described in the published documentation for a particular TI Resource.

Designer is authorized to use, copy and modify any individual TI Resource only in connection with the development of applications that include the TI product(s) identified in such TI Resource. NO OTHER LICENSE, EXPRESS OR IMPLIED, BY ESTOPPEL OR OTHERWISE TO ANY OTHER TI INTELLECTUAL PROPERTY RIGHT, AND NO LICENSE TO ANY TECHNOLOGY OR INTELLECTUAL PROPERTY RIGHT OF TI OR ANY THIRD PARTY IS GRANTED HEREIN, including but not limited to any patent right, copyright, mask work right, or other intellectual property right relating to any combination, machine, or process in which TI products or services are used. Information regarding or referencing third-party products or services does not constitute a license to use such products or services, or a warranty or endorsement thereof. Use of TI Resources may require a license from a third party under the patents or other intellectual property of the third party, or a license from TI under the patents or other intellectual property of TI.

TI RESOURCES ARE PROVIDED "AS IS" AND WITH ALL FAULTS. TI DISCLAIMS ALL OTHER WARRANTIES OR REPRESENTATIONS, EXPRESS OR IMPLIED, REGARDING RESOURCES OR USE THEREOF, INCLUDING BUT NOT LIMITED TO ACCURACY OR COMPLETENESS, TITLE, ANY EPIDEMIC FAILURE WARRANTY AND ANY IMPLIED WARRANTIES OF MERCHANTABILITY, FITNESS FOR A PARTICULAR PURPOSE, AND NON-INFRINGEMENT OF ANY THIRD PARTY INTELLECTUAL PROPERTY RIGHTS. TI SHALL NOT BE LIABLE FOR AND SHALL NOT DEFEND OR INDEMNIFY DESIGNER AGAINST ANY CLAIM, INCLUDING BUT NOT LIMITED TO ANY INFRINGEMENT CLAIM THAT RELATES TO OR IS BASED ON ANY COMBINATION OF PRODUCTS EVEN IF DESCRIBED IN TI RESOURCES OR OTHERWISE. IN NO EVENT SHALL TI BE LIABLE FOR ANY ACTUAL, DIRECT, SPECIAL, COLLATERAL, INDIRECT, PUNITIVE, INCIDENTAL, CONSEQUENTIAL OR EXEMPLARY DAMAGES IN CONNECTION WITH OR ARISING OUT OF TI RESOURCES OR USE THEREOF, AND REGARDLESS OF WHETHER TI HAS BEEN ADVISED OF THE POSSIBILITY OF SUCH DAMAGES.

Unless TI has explicitly designated an individual product as meeting the requirements of a particular industry standard (e.g., ISO/TS 16949 and ISO 26262), TI is not responsible for any failure to meet such industry standard requirements.

Where TI specifically promotes products as facilitating functional safety or as compliant with industry functional safety standards, such products are intended to help enable customers to design and create their own applications that meet applicable functional safety standards and requirements. Using products in an application does not by itself establish any safety features in the application. Designers must ensure compliance with safety-related requirements and standards applicable to their applications. Designer may not use any TI products in life-critical medical equipment unless authorized officers of the parties have executed a special contract specifically governing such use. Life-critical medical equipment is medical equipment where failure of such equipment would cause serious bodily injury or death (e.g., life support, pacemakers, defibrillators, heart pumps, neurostimulators, and implantables). Such equipment includes, without limitation, all medical devices identified by the U.S. Food and Drug Administration as Class III devices and equivalent classifications outside the U.S.

TI may expressly designate certain products as completing a particular qualification (e.g., Q100, Military Grade, or Enhanced Product). Designers agree that it has the necessary expertise to select the product with the appropriate qualification designation for their applications and that proper product selection is at Designers' own risk. Designers are solely responsible for compliance with all legal and regulatory requirements in connection with such selection.

Designer will fully indemnify TI and its representatives against any damages, costs, losses, and/or liabilities arising out of Designer's non-compliance with the terms and provisions of this Notice.